



# **hatho**

**rotierende Polierwerkzeuge**  
**rotating polishing instruments**

**outils rotatifs de polissage**

**herramientas rotativas de pulido**  
**spazzole per lucidare**

2016  
2017  
2018  
2019



# INHALT

## CONTENTS INDEX

### ÍNDICE INDICE

Seite  
Page

1		<b>HoPla - Bürsten, Rundbürsten mit Holzkern</b>	8
		HoPla - Lathe Brushes with plastic and wooden core	
		HoPla - Brosses circulaires avec centre en plastique et bois	
		HoPla - Cepillos para el pulido con centro de plástico y madera	
		HoPla - Spazzole HoPla con centro in plastica e legno	
		<b>Einlagebürsten</b>	16
		Poly - Buffs	
		Brosses avec disques intercalés	
		Cepillos con entretelas	17
		Spazzole con strati intermedi	
2		<b>Schmalbürsten</b>	18
		Slimline Brushes	
		Brosses au centre métallique	
		Cepillos de forma estrecha	
		Spazzole con centro metallico	21
3		<b>Polierschwabbeln</b>	22
		Polishing Discs	
		Disques de polissage	
		Discos de pulido	
		Dischi per lucidare	29
4		<b>HABRAS Bürsten, HABRAS Discs</b>	30
		HABRAS Brushes, HABRAS Discs	
		Brosses HABRAS, HABRAS Discs	
		Cepillos HABRAS, HABRAS Discs	
		HABRAS Spazzole, HABRAS Discs	
			35
5		<b>Miniaturbürsten</b>	36
		Miniature Brushes	
		Brossettes Miniatures	
		Cepillos Miniaturas	
		Spazzole Miniatur	43
6		<b>Miniaturschwabbeln</b>	44
		Miniature Polishing Discs	
		Disques miniatures à polir	
		Discos miniaturas de pulimento	
		Dischi miniatur per lucidare	
			45

7		<p><b>Filzpolierkörper</b> Felt polishers Feutres Filtros para pulir Feltri per lucidare</p>	<p><b>46</b> <b>47</b></p>
8		<p><b>HATHOfex S plus P</b> HATHOfex S plus P</p>	<p><b>48</b> <b>49</b></p>
9		<p><b>Minibestbürsten</b> Minibest Brushes Brosses Minibest Cepillos Minibest Spazzole Minibest</p>	<p><b>50</b> <b>51</b></p>
10		<p><b>Miniatürkelle, Miniaturpinsel (Endbürsten)</b> Miniature Brushes cup shaped, End Brushes Brosses miniatures en forme de coupe, Mini pinceaux Cepillos miniaturas en forma de copa, pinceles Spazzole miniatura coppetta, pennelli</p>	<p><b>52</b> <b>57</b></p>
11		<p><b>Picobürsten, Microbürsten</b> Pico Brushes, Micro Brushes Brossettes Pico, Brossettes Micro Cepillos Pico, Cepillos Micro Spazzole Pico, Spazzole Micro</p>	<p><b>58</b> <b>61</b></p>
12		<p><b>Diamantierte Bürsten und Polierer, DiaDisc, DiaStone</b> Diamond Brushes and Polishers, DiaDisc, DiaStone Brosses et polissoirs diamantés, DiaDisc, DiaStone Cepillos y pulidores diamantados, DiaDisc, DiaStone Spazzole diamantate e lucidanti, DiaDisc, DiaStone</p>	<p><b>62</b> <b>63</b></p>
13		<p><b>Polistar Polierpasten, Mandrels, Werkzeugständer</b> Polistar Polishing Compounds, Mandrels, Instrument Holder Pâtes à polir Polistar, Mandrins, présentoir vide Pastas de pulido Polistar, Mandriles, expositores Paste per lucidare Polistar, Mandrini, Portastrumenti</p>	<p><b>64</b> <b>67</b></p>
14		<p><b>FiberDisc, Naturhaarpinsel, Spindeladapter, Mattschlagbürsten</b> FiberDisc, Natural Hair Brush, Bur Chucks, Matting Brushes FiberDisc, Pinceau en soies naturelles, Porte-brossette, Brosses à mater FiberDisc, Cepillos de pelos naturales, Porta cepillos, Cepillos para matar FiberDisc, Pennelli in setole naturali, Adattatori di mandrini, Spazzole per satinare</p>	<p><b>68</b> <b>71</b></p>

## The HATHO Team • L'équipe HATHO • El equipo HATHO • Il Team HATHO

möchte Ihnen mit diesem Katalog unser umfangreiches Sortiment an rotierenden Polierwerkzeugen vorstellen.  
Alle unsere Produkte werden von uns in Eschbach im schönen Markgräflerland hergestellt.  
Wir freuen uns, wenn Sie bei uns das von Ihnen gesuchte Produkt finden können.

would like to present to you with this catalog the large product range of rotating polishing instruments .  
All our products are produced in Eschbach, a town located in one of the loveliest areas of Germany called Markgräflerland.  
We hope you will find the product you are looking for in this comprehensive catalog.

vous présente avec ce catalogue une très large gamme d'article d'outils de polissage rotatif.  
Tous nos produits sont fabriqués à Eschbach, une ville située dans la belle région de Markgräflerland.  
Nous serions très heureux si vous aller trouver les articles demandés.

Nos complace presentarles con este catálogo nuestra amplia gama de herramientas rotativas.  
Todos los productos están fabricados por nuestra compañía en Eschbach, ciudad situada en la maravillosa región alemana de Markgräflerland. Esperamos que pueden encontrar el producto que están buscando en nuestro catálogo.

Con questo nuovo catalogo il Team Hatho vi vuole presentare l'ampio assortimento dei suoi prodotti, che vengono fabbricati nel nostro stabilimento di Eschbach nella piacevole regione tedesca del Markgräflerland.  
Saremmo lieti di sapere se, tra i nostri prodotti, avete trovato quanto cercavate.



**Maren Holzmann**  
Produktmanagerin  
Product Manager  
Chef de produits  
Jefe de productos  
Dirigente dei prodotti



**Paul Degrande**  
Senior Produktmanager  
Senior Product Manager  
Senior chef de produits  
Senior Jefe de Productos  
Senior dirigente dei prodotti



**Dr. Ralf Steiner**  
Geschäftsführer  
Managing Director  
Directeur  
Director gerente  
Direttore dell'azienda



**Anna von Sponeck**  
Assistentin der Geschäftsleitung  
Assistant to the Managing Director  
Assistante de direction  
Assistente della direzione  
Ayudante de dirección



**Astrit Thomann**  
Verkaufsleiterin  
Head of Sales  
Chef de ventes  
Jefe de ventas  
Direttrice delle vendite



**Christina Schütz**  
Vertriebsleiterin  
Head of Distribution  
Chef de la distribution  
Jefe de la distribución  
Direttrice della distribuzione



**Bernhard Brugger**  
Produktionsleiter,  
Qualitätsbeauftragter  
Head of Production,  
Quality Manager  
Directeur technique,  
responsable de la qualité  
Director técnico,  
responsable de la calidad  
Direttore di produzione,  
responsabile della qualità



**Rolf-Dieter Ulitzka**  
stellv. Produktionsleiter  
Deputy Head of Production  
Directeur de production adjoint  
Director adjunto de producción  
Direttore di produzione vicario



**Lucia Fucci**  
Leiterin Versandabteilung  
Head of shipping department  
Chef service des expéditions  
Jefe de departamento de envíos  
Direttrice della spedizione



**Barbara Raach**  
Buchhaltung  
Accounts Department  
Comptabilité  
Contabilidad  
Contabilità



**Nicoletta Caruso**  
Disposition  
Planning  
Disposition  
Disposizione  
Responsabile del magazzino



**Nadine Wehrle**  
Leiterin Verpackungsabteilung  
Head of packaging department  
Chef département emballage  
Jefe departamento embalaje  
Direttrice del reparto di imballaggio



**Janine Haase**  
Auftragsabwicklung  
Order Processing  
Gestion des commandes  
Gestión de los pedidos  
Disbrigo degli ordini

## Perfektion für Oberflächen

Perfection for Surfaces

Perfection des surfaces

Perfección para las superficies

La perfezione per le superfici



**Verbesserung des Bestehenden und Entwicklung von Neuem: so lauten die Prämissen von HATHO.**

Sie betreffen sämtliche Produktionsmittel und - abläufe und vor allem jedes einzelne Produkt. Ein lebendiger Kreislauf der Optimierungen und Innovationen, der nicht zum Stillstand kommt. Die logische Konsequenz des hohen Anspruchs sind eine Vielzahl neuer Anwendungen und Produkte, nationale und internationale Patente sowie ein Qualitätsmanagement gemäß ISO 9001:2008.

**The improvement of what is and the development of what will be – these are HATHO's priorities.**

They apply to every production material and, above all, to every single product. A dynamic and never ending cycle of optimisation and innovation is created. The logical result of such high standards is a wide range of new applications and products, national and international patents and a certified quality management according to ISO 9001:2008.



**L'amélioration de l'existant et le développement de nouveautés sont les prémisses de la maison HATHO: les moyens et les processus de productions bénéficient à tous les produits.**

C'est un cycle d'optimisations et d'innovations qui ne s'arrête jamais. La conséquence logique est un grand nombre de nouveaux produits et applications, ainsi que de brevets nationaux et internationaux et la gestion de la qualité des produits, certifiée ISO 9001 :2008.



**Perfeccionamiento de lo existente y desarrollo de lo nuevo: esas son las premisas de HATHO. Se aplican a todos los medios y procesos de producción, en particular, a cada producto.**

Un ciclo dinámico de optimización e innovación, que nunca se termina. La consecuencia lógica de tales exigencias muy elevadas es una multiplicidad de nuevas aplicaciones y productos, patentes nacionales e internacionales. La gestión de calidad está certificada según ISO 9001:2008.

**Migliorare il prodotto esistente e sviluppare le novità: queste sono le premesse della HATHO, che riguardano mezzi ed i processi di produzione di ogni singolo articolo.**

Un ciclo continuo e dinamico di miglioramenti ed innovazioni. Il risultato logico di standard così alti é un ampio raggio di nuove applicazioni e di nuovi prodotti, brevetti nazionali ed internazionali e certificazioni quali l'ISO 9001:2008.

### HATHO HoPla

Eine Holzbuchse im Zentrum des Kunststoffkerns  
 Wooden center encased in plastic core  
 Noyau plastique avec un centre en bois  
 Un casquillo de madera en el centro plástico  
 Un nocciolo in legno nel centro del mozzo di plastica



### HATHO Pico Bürsten

Polierbürsten mit zehn Millimeter Durchmesser für filigrane Zwischenräume  
 Polishing brushes Ø 10 mm for small interdental areas  
 Brochettes à polir Ø 10 mm pour des espaces filigrane  
 Cepillos con un diametro de 10 mm para el pulido de intersticios filigranes  
 Spazzole per lucidare con un diametro di 10 mm per spezi piccolissimi



### HATHO Brechflansch Removable ring system Anneaux détachables Anillos desmontables Anelli smontabili

Abbrechbares Ringsystem zur seitlichen Stabilisierung der Schwabbeln  
 Removable ring system, provides lateral stability to polishing discs  
 Disques à anneaux détachables donnent une stabilité maximale  
 Anillos desmontables para la estabilización lateral del disco de pulido  
 Sistema di rottura degli anelli, che garantisce una stabilità laterale della spazzola



### HATHO UniFix

Kunststoffkern mit abgestuftem Zentrum zur besseren Fixierung und Zentrierung der Polierschwabbeln  
 Plastic core with stepped arbour hole for better fixing and centering on the spindle  
 Noyau en plastique avec un centre gradué pour fixation et centrage optimal des disques à polir  
 Núcleo de plástico con centro escalonado para mejor fijación y centrado de disco de pulido  
 Mozzo in plastica con centro graduato per facilitare il fissaggio e il centraggio della spazzola

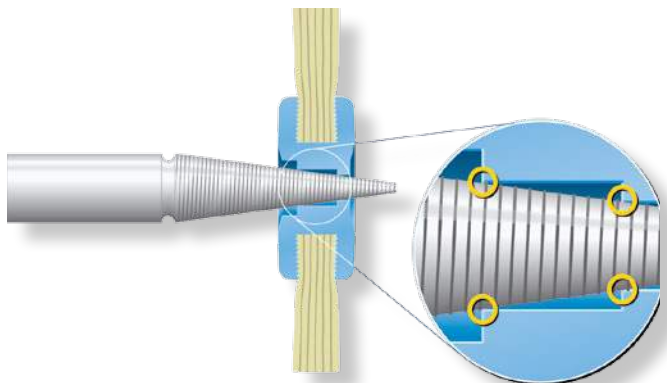

### HATHO FILIO®

Adapter zur Montage von Schaftbürsten auf Poliermotor  
 Adapter for mounting shank brushes on conical spindles of a polishing unit  
 Adapteur pour monter les brosses miniatures sur tige au moteur à polir  
 Un adaptador para el montaje de los cepillos de vástago en las máquinas de pulimento  
 Adattatore per il montaggio di spazzole con gambo

**Umrechnungstabelle Inch/mm**  
**Conversion chart Inch/mm**  
**Tableau comparatif Inch/mm**  
**Indicator comparativo Inch/mm**  
**Tabella di conversione Inch/mm**

	0.003"	0,076 mm
	0.004"	0,102 mm
	0.005"	0,127 mm
	0.006"	0,152 mm
3/32"	0.094"	2,381 mm
1/8"	0.125"	3,175 mm
3/16"	0.188"	4,762 mm
1/4"	0.250"	6,350 mm
9/32"	0.281"	7,144 mm
3/8"	0.375"	9,525 mm
1/2"	0.500"	12,70 mm
9/16"	0.563"	14,29 mm
11/16"	0.688"	17,46 mm
3/4"	0.75"	19,05 mm
1"	1.0"	25,40 mm
2"	2.0"	50,80 mm
3"	3.0"	76,20 mm
4"	4.0"	102 mm
5"	5.0"	127 mm
6"	6.0"	152 mm

**Schaftdurchmesser Inch/mm**  
**Shank diameter Inch/mm**  
**Diamètre de la tige Inch/mm**  
**Diámetro del vástago Inch/mm**  
**Diametro del gambo Inch/mm**

HP	3/32"	2,34 mm
HP.B		3 mm
HP.C	1/8"	3,17 mm
HP.6		6 mm

**Bohrungsdurchmesser**  
**unmontierter Bürsten Inch/mm**  
**Arbor hole diameter of unmounted**  
**brushes Inch/mm**  
**Diamètre d'alésage d'une brosse**  
**non montée**  
**El diámetro de vástago de los**  
**cepillos non montado**  
**Diametro del foro centrale delle**  
**spazzole non montate**

RED		1,8 mm
UM		2,5 mm
UMC	1/8"	3,17 mm

**Verpackungseinheit**  
**Packing unit**  
**Nombre de pièces par emballage**  
**Número de piezas per embalaje**  
**Unità di imballaggio**



Beispiele  
 exemples  
 exemples  
 ejemplos  
 esempi





**HoPla - Bürsten, Rundbürsten mit Holzkern**  
**HoPla - Lathe Brushes with plastic and wooden core**  
**HoPla - Brosses circulaires avec centre en plastique et bois**  
**HoPla - Cepillos para el pulido con centro de plástico y madera**  
**HoPla - Spazzole HoPla con centro in plastica e legno**

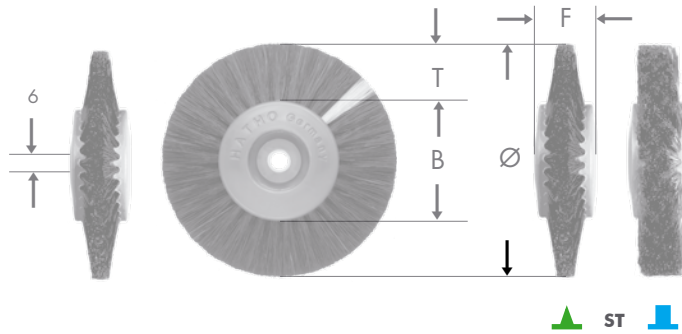

**Besatzmaterial** schwarze oder weiße Chungking Borsten  
**filling material** black or white Chungking bristles  
**matériel de garniture** soie de Tchong King noire ou blanche  
**guarnición** cerda de Chung King negra o blanca  
**materiale utilizzato** setola die Chungking nera o bianca

**ZR =** Zahl der Reihen  
 numbers of rows  
 nombres de rangs  
 número de hileras  
 numero dei ranghi

1:2

↻ 2.800















Art.Nr. art.No.	ZR	Ø mm	B mm	T mm	ST
1135	1	35	25	5	-
1144	1	44	25	9,5	-
0144	1	44	25	9,5	-
1145	1	45	25	9,5	-
H 104	1	48	22	13	-
1150 H	1	50	26	12	-
1160 H	1	60	32	14	-



















1:2

↻ 2.800



	Art.Nr. art.No.	ZR	Ø mm	B mm	T mm	ST
	<b>1165 H</b>	1	65	40	12,5	-
	<b>SE 1C</b>	1	67	48	9,5	-
	<b>1245</b>	2	45	25	9,5	▲
	<b>1250</b>	2	50	25	12,5	▲
	<b>1250 H</b>	2	50	25	12,5	▲
	<b>0250</b>	2	50	25	8,5	▲
	<b>0250 H</b>	2	50	25	8,5	▲
	<b>SE 6C</b>	2	51	32	9,5	▲
	<b>H 114</b>	2	54	25	14,5	▲
	<b>1255</b>	2	55	33	11	▲
	<b>1255 H</b>	2	55	33	11	▲
	<b>0255</b>	2	55	33	11	▲
	<b>0255 H</b>	2	55	33	11	▲

	Art.Nr. art.No.	ZR	Ø mm	B mm	T mm	ST
	<b>1260</b>	2	60	40	10	▲
	<b>1260 H</b>	2	60	35	12,5	▲
						
	<b>H 120</b>	2	64	32	16	▲
	<b>1265</b>	2	65	45	10	▲
	<b>1265 H</b>	2	65	40	12,5	▲
						
	<b>SE 2C</b>	2	67	48	9,5	▲
	<b>1270</b>	2	70	50	10	▲
	<b>1270 H</b>	2	70	50	10	▲
						
	<b>SE 2B</b>	2	73	48	12,5	▲
						
	<b>1280 H</b>	2	80	40	20	▲

	Art.Nr. art.No.	ZR	Ø mm	B mm	T mm	ST
	<b>1355</b>	3	55	28	13,5	▲
	<b>1355 H</b>	3	55	28	13,5	▲
	<b>0355</b>	3	55	28	13,5	▲
	<b>H 124</b>	3	58	32	13	▲
	<b>1360 H</b>	3	60	35	12,5	▲
	<b>1370</b>	3	70	40	15	▲
	<b>1370 H</b>	3	70	40	15	▲
	<b>0370</b>	3	70	40	15	▲
	<b>H 123</b>	3	70	32	19	▲
	<b>1380 H</b>	3	80	40	20	▲

	Art.Nr. art.No.	ZR	Ø mm	B mm	T mm	ST
	<b>137</b>	3	70	40	15	⬇️
	<b>137 H</b>	3	70	40	15	⬇️
	<b>037</b>	3	70	40	15	⬇️
	<b>138</b>	3	80	40	20	⬇️
	<b>138 H</b>	3	80	40	20	⬇️
	<b>1399 H</b>	3	100	60	20	⬆️
	<b>1460</b>	4	60	40	10	⬆️
	<b>1460 H</b>	4	60	35	12,5	⬆️
	<b>1465 H</b>	4	65	35	15	⬆️
	<b>1470 H</b>	4	70	40	15	⬆️

	Art.Nr. art.No.	ZR	Ø mm	B mm	T mm	ST
	<b>1475 H</b>	4	75	40	17,5	▲
	<b>1480</b>	4	80	40	20	▲
	<b>1480 H</b>	4	80	40	20	▲
	<b>0480</b>	4	80	40	20	▲
	<b>1480 EH</b>	4	80	40	20	▲
	<b>1480 H/EH</b>	4	80	40	20	▲
extra hart extra hard extra dur extra dura extra dura						
	<b>4R 80 121</b>	4	80	40	20	▲
super hart super hard super dur super dura super dura						
	<b>4R 80 120</b>	4	80	40	20	▲
super hart super hard super dur super dura super dura						

		Art.Nr. art.No.	ZR	Ø mm	B mm	T mm	ST
		<b>146 EH</b>	4	60	40	10	
		<b>146 H/EH</b>	4	65	35	15	
		<b>147 H</b>	4	70	40	15	
		<b>H 129</b>	4	76	38	19	
		<b>148</b>	4	80	40	20	
		<b>148 H</b>	4	80	40	20	
		<b>148 H/EH</b>	4	80	40	20	
		extra hart extra hard extra dur extra dura extra dura					
		<b>1499 H</b>	4	100	60	20	

	<b>Art.Nr. art.No.</b>	<b>ZR</b>	<b>Ø mm</b>	<b>B mm</b>	<b>T mm</b>	<b>ST</b>
	<b>156 H</b>	<b>5</b>	<b>60</b>	<b>40</b>	<b>10</b>	
	<b>1599 H</b>	<b>5</b>	<b>100</b>	<b>60</b>	<b>20</b>	
	<b>1699 H</b>	<b>6</b>	<b>100</b>	<b>60</b>	<b>20</b>	
	weißes Ziegenhaar white goat hair poils de chèvre blancs pelo de cabra blanco pelo di capra bianco	<b>4</b>	<b>80</b>	<b>40</b>	<b>20</b>	
	Tampico fiber Tampico fibre Tampico fibre Tampico fibre Tampico fibra	<b>4</b>	<b>90</b>	<b>50</b>	<b>20</b>	
	<b>121 35 Palatinal</b>		<b>35</b>	<b>14</b>		



**Einlagebürsten**  
**Poly - Buffs**  
**Brosses avec disques intercalés**  
**Cepillos con entretelas**  
**Spazzole con strati intermedi**

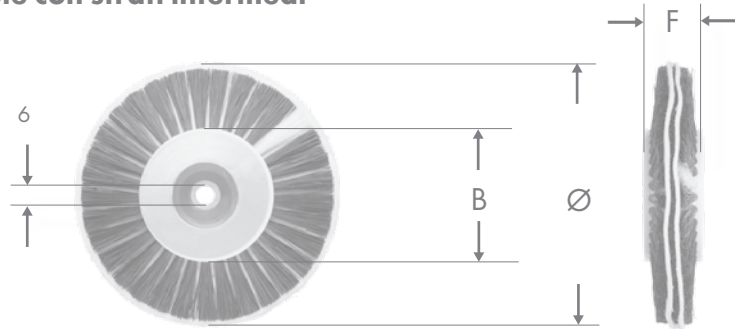

↻ 2.800









	Art.Nr. art.No.	Ø mm	B mm	F mm
<p>schwarze Chungking Borsten, Nesselstoffscheiben                      black Chungking bristles, muslin discs                      soie de Tchong King noire, disques en mousseline                      cerda de Chung King negra, entretelas de muselina                      setola di Chungking nera, strati di mussola</p>	5250	50	25	13
	5365	65	35	17
	5380	80	40	18
	5480	80	40	24
<p>schwarze Chungking Borsten, Filztuchscheiben                      black Chungking bristles, felt cloth discs                      soie de Tchong King noire, toile de feutre                      cerda de Chung King negra, paño de fieltro                      setola di Chungking nera, strati di feltro</p>	6380	80	40	18
	6480	80	40	24
<p>schwarze Chungking Borsten, Lederscheiben                      black Chungking bristles, leather discs                      soie de Tchong King noire, disques peau de chamois                      cerda de Chung King negra, entretelas de cuero                      setola di Chungking nera, strati di pelle</p>	7380	80	40	18
	7480	80	40	23



2.800

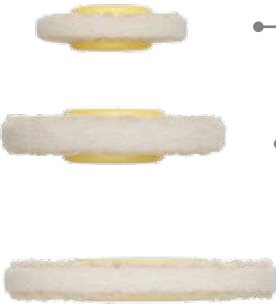

	Art.Nr. art.No.	Ø mm	B mm	F mm
<p>weiße Chungking Borsten, Scotch Brite™ white Chungking bristles, Scotch Brite™ soie de Tchong King blanche, disques de Scotch Brite™ cerda de Chung King blanca, entretelas de Scotch Brite™ setola di Chungking bianca, strati di Scotch Brite™</p>  	4280	80	40	15
<p>schwarze Chungking Borsten, silikoniertes Baumwollgewebe black Chungking bristles, silicon coated cotton fabric soie de Tchong King noire, tissu de coton siliconé cerda de Chung King negra, tejido de algodón siliconado setola di Chungking nera, tessuto di cotone siliconato</p>  	8277	77	40	18
<p>weiße Chungking Borsten, ZETA Tuch, weißes Scotch Brite™ white Chungking bristles, ZETA cloth, white Scotch Brite™ soie de Tchong King blanche, tissu ZETA, disques de Scotch Brite™ blanche cerda de Chung King blanca, paño ZETA, entretelas de Scotch Brite™ blanca setola di Chungking bianca, panno ZETA, strati di Scotch Brite™ bianco</p>  	8280	80	40	14
<p>weiße Chungking Borsten, weißes Scotch Brite™ white Chungking bristles, white Scotch Brite™ soie de Tchong King blanche, disques de Scotch Brite™ blanche cerda de Chung King blanca, entretelas de Scotch Brite™ blanca setola di Chungking bianca, strati di Scotch Brite™ bianco</p>  	9245	45	25	13
	9255	55	25	13
	9280	80	40	14





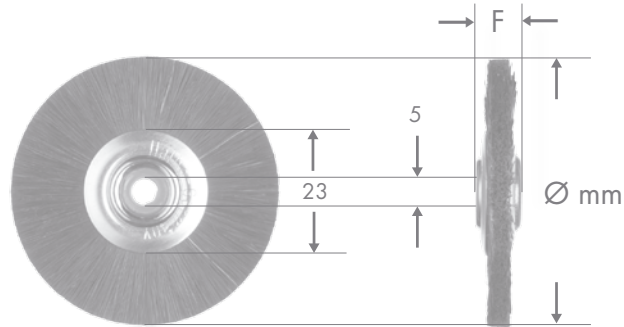















**Schmalbürsten**  
**Slimline Brushes**  
**Brosses au centre métallique**  
**Cepillos de forma estrecha**  
**Spazzole con centro metallico**



**Besatzmaterial**  
**filling material**  
**matériel de garniture**  
**guarnición**  
**materiale utilizzato**

















	Ø 36	Ø 42	Ø 48	Ø 51	Ø 60
<b>weißes Ziegenhaar</b> white goat hair poils de chèvre blancs pelo de cabra blanco pelo di capra bianco  ↻ 2.800					
		<b>100 42</b>	<b>100 48</b>	<b>100 51</b>	<b>100 60</b>
<b>schwarze Chungking Borsten</b> black Chungking bristles soie de Tchong King noire cerda de Chung King negra setola di Chungking nera  ↻ 2.800					
	<b>121 36</b>	<b>121 42</b>	<b>121 48</b>	<b>121 51</b>	<b>121 60</b>
<b>weiße Chungking Borsten</b> white Chungking bristles soie de Tchong King blanche cerda de Chung King bianca setola di Chungking bianca  ↻ 2.800					
		<b>120 42</b>	<b>120 48</b>	<b>120 51</b>	<b>120 60</b>
<b>grober Baumwollfaden</b> coarse cotton thread fil de coton dur hilo de algodón grueso filo di cotone grosso  ↻ 1.400					
		<b>150 42</b>	<b>150 48</b>	<b>150 51</b>	<b>150 60</b>



	Ø 36	Ø 42	Ø 48	Ø 51	
graues Pferdehaar grey horse hair crins de cheval gris crin de caballo gris crine di cavallo grigio  2.800			 <b>112 48</b>		
graues Ziegenhaar grey goat hair poils de chèvre gris pelo de cabra gris pelo di capra grigio  2.800			 <b>102 48</b>		
gewellter Messingdraht crimped brass wire fil de laiton ondulé alambre de latón ondulado filo di ottone ondulado  1.400      Ø 0,10 mm		 <b>143 42</b>	 <b>143 48</b>	 <b>143 51</b>	
gewellter Edelstahlbraht crimped stainless steel wire fil d'acier inoxydable ondulé alambre de acero inoxidable ondulado filo d'acciaio inossidabile ondulado  1.400      Ø 0,06 mm Ø 0,10 mm	 <b>181 36</b>		 <b>181 48</b>	 <b>183 51</b>	
glatter Edelstahlbraht straight stainless steel wire fil d'acier inoxydable lisse alambre de acero inoxidable liso filo d'acciaio inossidabile liscio  1.400      Ø 0,08 mm				 <b>682 51</b>	
gewellter Stahldraht crimped steel wire fil d'acier ondulé alambre de acero ondulado filo d'acciaio ondulado  1.400      Ø 0,10 mm				 <b>193 51</b>	
	Ø 32	Ø 38	Ø 51		
Nylonfaser Nylon filament fibres de nylon fibra de nylon fibra di nylon  2.800      Ø 0,15 mm Ø 0,30 mm	 <b>282 32</b>	 <b>282 38</b>	 <b>282 51</b> <b>286 51</b>		



**Schmalbürsten**  
**Slimline Brushes**  
**Brosses au centre métallique**  
**Cepillos de forma estrecha**  
**Spazzole con centro metallico**

<p>Ziegenhaar            Microfaser Leder            goat hair            microfiber leather            poils de chèvre et            cuir microfibre            pelo de cabra            cuero de microfibra            pelo di capra            pelle in microfibra</p> <p>↳ 2.800</p>	<p>Ø 48</p>  <p><b>100/520 48</b></p>	<p>12</p>	<p>Scotch Brite™            Scotch Brite™            Scotch Brite™            Scotch Brite™            Scotch Brite™</p> <p>↳ 1.400</p>	<p>grob            coarse            dur            grueso            grosso</p>	<p>Ø 51</p>  <p><b>250 51</b></p>	<p>2</p>
	<p>Ø 51</p>  <p><b>100/520 51</b></p>				<p>ohne Schleifmittel            no abrasives            sans grain            sin grano            senza grana</p> <p>↳ 1.400</p>	
<p>schwarze Chungking Borsten            Nesselstoff Einlage            black Chung King bristles            muslin insert            soie de Tchong King noir et            mousseline            cerda de Chung King negra            intermedia de muselina            Setola di Chungking nera            con strato di mussola</p> <p>↳ 2.800</p>	<p>Ø 48</p>  <p><b>121 48 NE</b></p>	<p>12</p>	<p>grob gebunden            coarse bonded            dur lié            gruesa ligado            grana grossa</p> <p>↳ 1.400</p>	<p>Ø 51</p>  <p><b>254 51</b></p>	<p>2</p>	
	<p>Ø 48</p>  <p><b>121 48 VL</b></p>			<p>Mikrofaser-Leder            microfiber leather discs            cuir de microfibre            cuero de microfibra            pelle in microfibra</p> <p>↳ 1.400</p>		<p>Ø 51</p>  <p><b>520 51</b></p>
<p>schwarze Chungking Borsten            weißem Scotch Brite™            black Chung King bristles            with white Scotch Brite™ discs            soie de Tchong King noir et            avec Scotch Brite™ blanc            cerda de Chung King negra            intermedia de Scotch Brite™            blanco            Setola di Chungking nera            con strato intermedio di            Scotch Brite™ bianco</p> <p>↳ 2.800</p>	<p>Ø 48</p>  <p><b>121 48 VL</b></p>	<p>12</p>	<p>↳ 1.400</p>	<p>Ø 60</p>  <p><b>520 60</b></p>	<p>2</p>	
	<p>Ø 48</p>  <p><b>164 48</b></p>			<p><b>COSIMA soft</b></p>		<p>Ø 51</p>  <p><b>869 51</b></p>
<p>Nesselstoff            muslin cloth            disques en toile            muselina            mussola tinta</p> <p>↳ 2.800</p>	<p>Ø 48</p>  <p><b>164 48</b></p>	<p>12</p>	<p>Weiches silikoniertes            Baumwollgewebe            soft silicon coated cotton            fabric            tissu de coton doux et            siliconé            tejido blando de algodón            siliconado            tessuto di cotone            siliconato morbido</p> <p>↳ 1.400</p>	<p>Ø 60</p>  <p><b>869 60</b></p>	<p>2</p>	
	<p>Ø 51</p>  <p><b>500 51</b></p>			<p><b>COSIMA</b></p>		<p>Ø 51</p>  <p><b>870 51</b></p>
<p>Wildleder            chamois leather            peau de chamois            cuero de gamuza            pelle di camoscio</p> <p>↳ 1.400</p>	<p>Ø 60</p>  <p><b>500 60</b></p>	<p>12</p>	<p>↳ 1.400</p>	<p>Ø 60</p>  <p><b>870 60</b></p>	<p>2</p>	

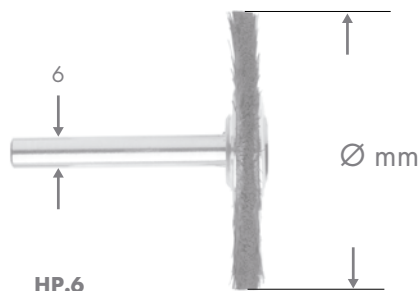

HP.6

∅ 1.400	∅ 51	∅ 1.400	∅ 51
<p>weißes Ziegenhaar weich white goat hair soft poils de chèvre blancs pelo de cabra blanco pelo di capra bianco</p>	<p><b>100 51 HP.6</b></p>	<p>schwarze Chungking Borste black Chungking bristles soie de Tchong King noire cerda de Chung King negra setola di Chungking nera</p>	<p><b>121 51 HP.6</b></p>
<p>Baumwollfaden cotton thread fil de coton hilo de algodón filo di cotone</p>	<p><b>150 51 HP.6</b></p>	<p>gewellter Edelstahlraht crimped stainless steel wire fil d'acier inoxydable ondulé alambre de acero inoxidable ondulado filo d'acciaio inossidabile ondulato</p> <p>∅ 0,10 mm</p>	<p><b>183 51 HP.6</b></p>
<p>gewellter Stahdraht crimped steel wire fil d'acier ondulé alambre de acero ondulado filo d'acciaio ondulato</p> <p>∅ 0,10 mm</p>	<p><b>193 51 HP.6</b></p>	<p>Nylonfaser Nylon filament fibres de nylon fibra de nylon fibra di nylon</p> <p>∅ 0,15 mm</p>	<p><b>282 51 HP.6</b></p>
<p>Wildleder chamois leather peau de chamois cuero de gamuza pelle di camoscio</p>	<p><b>500 51 HP.6</b></p>	<p>Edelstahdraht glatt straight stainless steel wire fil d'acier inoxydable lisse alambre de acero inoxidable liso filo d'acciaio inossidabile liscio</p> <p>∅ 0,08 mm</p>	<p><b>682 51 HP.6</b></p>
<p>gewellter Messingdraht crimped brass wire fil de laiton ondulé alambre de latón ondulado filo di ottone ondulato</p> <p>∅ 0,10 mm</p>	<p><b>143 51 HP.6</b></p>	<p>Scotch Brite™ fein Scotch Brite™ fine Scotch Brite™ fin Scotch Brite™ fino Scotch Brite™ fine</p>	<p><b>252 51 HP.6</b></p>
<p>∅ 1.400</p>	<p>∅ 45</p>	<p>∅ 1.400</p>	<p>∅ 60</p>
<p>gewellter Stahdraht crimped steel wire fil d'acier ondulé alambre de acero ondulado filo d'acciaio ondulato</p> <p>∅ 0,10 mm</p>	<p><b>193 45 HP.6</b></p>	<p>gewellter Messingdraht crimped brass wire fil de laiton ondulé alambre de latón ondulado filo di ottone ondulato</p> <p>∅ 0,15 mm</p>	<p><b>145 60 HP.6</b></p>







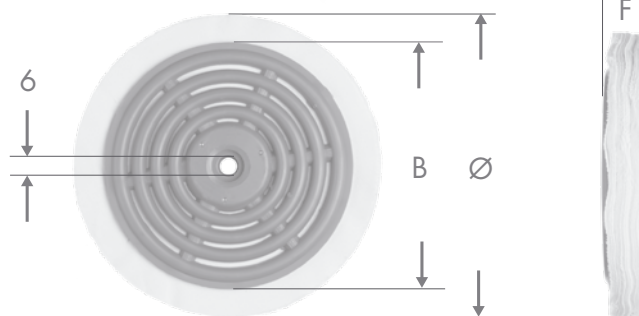

**Polierschwabbeln**  
**Polishing Discs**  
**Disques de polissage**  
**Discos de pulido**  
**Dischi per lucidare**



LZ = Lagenzahl  
 number of layers  
 nombre de disques  
 numero de hiladas  
 numero dei dischi

Ø 110 = ∅ 1.400    Ø 80 = ∅ 2.800



Art.Nr. art.No.	Material material	Ø mm	B mm	F mm	LZ
 <b>160 110 NE/45</b>	Nesselschwabbel muslin discs brosse en mousseline discos de muselina spazzola in mussola	110	90	20	45
<b>160 110 NE/30</b>		110	90	18	30
<b>160 80 NE/45</b>		80	63	20	45
<b>160 80 NE/30</b>		80	63	18	30
 <b>162 110 FI/12</b>	Filztuchschwabbel felt cloth discs brosse en feutre discos de fieltro spazzola in feltro	110	90	28	12
<b>162 110 FI/6</b>		110	90	18	6
<b>162 80 FI/12</b>		80	63	28	12
<b>162 80 FI/6</b>		80	63	18	6
 <b>500 110 CH/12</b>	Wildlederschwabbel chamois leather discs brosse en peau de chamois cuero de gamuza spazzola in camoscio	110	90	23	12
<b>500 110 CH/6</b>		110	90	18	6
<b>500 80 CH/12</b>		80	63	23	12
<b>500 80 CH/6</b>		80	63	18	6
 <b>520 110 CH/12</b>	Microfaser Leder microfiber leather cuir de microfibre cuero de microfibra pelle in microfibra	110	90	19	12
<b>520 110 CH/6</b>		110	90	16	6
<b>520 80 CH/12</b>		80	63	19	12
<b>520 80 CH/6</b>		80	63	16	6

Schleifvliesräder mit Scotch Brite™  
 Trimming Wheels with Scotch Brite™  
 Roues d'affilage en Scotch Brite™ abrasive  
 Muelas abrasivas Scotch Brite™  
 Dischi abrasivi in Scotch Brite™

VL/2



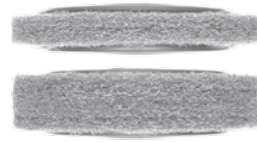







VL/4

















Ø 110 = ∩ 1.400 Ø 80 = ∩ 2.800







	Art.Nr. art.No.	Material material	Ø mm	B mm	F mm	LZ
	259 110 VL/4	extra grob extra coarse extra dur extra grueso extra grossa	110	90	44	4
	259 110 VL/2		110	90	26	2
	259 80 VL/4		80	63	40	4
	259 80 VL/2		80	63	26	2
	250 110 VL/4	grob coarse dur grueso grossa	110	90	33	4
	250 110 VL/2		110	90	23	2
	250 80 VL/4		80	63	29	4
	250 80 VL/2		80	63	18	2
	251 110 VL/4	mittel medium medium medio media	110	90	31	4
	251 110 VL/2		110	90	23	2
	251 80 VL/4		80	63	30	4
	251 80 VL/2		80	63	21	2
	252 110 VL/4	fein fine fin fino fine	110	90	30	4
	252 110 VL/2		110	90	21	2
	252 80 VL/4		80	63	25	4
	252 80 VL/2		80	63	18	2
	255 110 VL/4	fein fine fin fino fine	110	90	30	4
	255 110 VL/2		110	90	21	2
	255 80 VL/4		80	63	25	4
	255 80 VL/2		80	63	18	2
	253 110 VL/4	ohne Schleifmittel without abrasive sans grain sin grano senza grana	110	90	28	4
	253 110 VL/2		110	90	18	2
	253 80 VL/4		80	63	26	4
	253 80 VL/2		80	63	18	2

	Art.Nr. art.No.	Material material	Ø mm	B mm	F mm	LZ
	<b>165 100 Pli</b>	plissierte Nesselschwabbel pleated muslin discs brosse en mousseline plissée discos de muselina plisada spazzola in mussola plisseffata	<b>100</b>	<b>45</b>	<b>18</b>	<b>-</b>
	<b>166 100 F</b>	Nesselfaltschwabbel muslin discs slight pleats brosse en mousseline avec plis discos de muselina con arrugas spazzola in mussola arricciata	<b>100</b>	<b>43</b>	<b>16</b>	<b>-</b>
	<b>168 100 F</b>	Flanellfaltschwabbel flannel brush with slight pleats brosse en flanelle avec plis discos de franela con arrugas spazzola in flanela arricciata	<b>100</b>	<b>43</b>	<b>16</b>	<b>-</b>
	<b>168 80 F</b>		<b>80</b>	<b>43</b>	<b>16</b>	<b>-</b>
	 <b>161 100/20</b>	Flanellschwabbel flannel discs brosse en flanelle discos de franela spazzola in flanela	<b>100</b>	<b>40</b>	<b>17</b>	<b>20</b>
	 <b>162 100/6</b>	Filztuchschwabbel felt cloth discs brosse en feutre discos de fieltro spazzola in feltro	<b>100</b>	<b>40</b>	<b>18</b>	<b>6</b>
	 <b>163 100/40</b>	Feinstes Baumwoll- gewebe finest cotton fabric toile de coton très fine tejido de algodón muy fino tessuto di cotone molto fino	<b>100</b>	<b>40</b>	<b>16</b>	<b>40</b>
	 <b>164 100/20</b>	gebleichte Nesselschwabbel bleached muslin discs disque de mousseline blanchie cepillo de muselina blanqueada disco in mussola tinta	<b>100</b>	<b>40</b>	<b>15</b>	<b>20</b>
	<b>164 100/40</b>		<b>100</b>	<b>40</b>	<b>18</b>	<b>40</b>
	<b>164 100/55</b>		<b>100</b>	<b>40</b>	<b>20</b>	<b>55</b>







	Art.Nr. art.No.	Material material	Ø mm	B mm	F mm	LZ
	 <b>500 100/7</b>	Wildlederschwabbel chamois leather discs brosse en peau de chamois cuero de gamuza spazzola in camoscio	<b>100</b>	<b>40</b>	<b>16</b>	<b>7</b>
	 <b>500 80/7</b>		<b>80</b>	<b>40</b>	<b>19</b>	<b>7</b>
	 <b>500 90 LE</b>	Wildlederschwabbel chamois leather discs brosse en peau de chamois cuero de gamuza spazzola in camoscio	<b>90</b>	<b>40</b>	<b>18</b>	<b>-</b>
	 <b>520 100/7</b>	Microfaserleder microfiber leather discs cuir de microfibre cuero de microfibra pelle in microfibra	<b>100</b>	<b>40</b>	<b>15</b>	<b>7</b>
	 <b>520 90 LE</b>	Microfaserleder microfiber leather discs cuir de microfibre cuero de microfibra pelle in microfibra	<b>90</b>	<b>40</b>	<b>18</b>	<b>-</b>
	<b>ZETA</b>  <b>862 100/15</b>	Microfaser microfiber microfibre microfibra microfibra	<b>100</b>	<b>40</b>	<b>15</b>	<b>15</b>
	<b>COSIMA Soft</b>  <b>869 100/14</b>	Weiches silikonisiertes Baumwollgewebe soft silicon coated cotton fabric tissu de coton doux et siliconé	<b>100</b>	<b>40</b>	<b>10</b>	<b>14</b>
	<b>869 100/20</b>	tejido blando de algodón siliconado	<b>100</b>	<b>40</b>	<b>13</b>	<b>20</b>
	<b>869 100/28</b>	tessuto di cotone siliconato morbido	<b>100</b>	<b>40</b>	<b>20</b>	<b>28</b>
	<b>COSIMA</b>  <b>870 100/14</b>	Silikonisiertes Baumwoll- gewebe silicon coated cotton fabric tissu de coton siliconé tejido de algodón siliconado	<b>100</b>	<b>40</b>	<b>12</b>	<b>14</b>
	<b>870 100/22</b>	tessuto di cotone siliconato	<b>100</b>	<b>40</b>	<b>20</b>	<b>22</b>



	Art.Nr. art.No.	Material material	Ø mm	B mm	F mm
	<b>873 125x24 K</b>	Dichtes Baumwollgewebe dense fine cotton fabric toile dense de coton tejido de algodón denso tessuto di cotone fitto	<b>125</b>	<b>51</b>	<b>24</b>
	<b>873 125x30 K</b>		<b>125</b>	<b>51</b>	<b>30</b>
	<b>163 125x24 K</b>	Feinstes Baumwollgewebe finest cotton fabric toile de coton très fine tejido de algodón muy fino tessuto di cotone molto fino	<b>125</b>	<b>51</b>	<b>24</b>
	<b>163 125x30 K</b>		<b>125</b>	<b>51</b>	<b>30</b>
	<b>161 125x24 K</b>	Weiches Baumwollgewebe soft fine cotton fabric toile de coton fine et doux tejido de algodón blando tessuto di cotone morbido	<b>125</b>	<b>51</b>	<b>24</b>
	<b>161 125x30 K</b>		<b>125</b>	<b>51</b>	<b>30</b>
	<b>162 125x24 K</b>	Gewalkte Schafswolle felted lamb's wool laine de mouton feutrée lana de oveja abatanada lana di pecora infeltrita	<b>125</b>	<b>51</b>	<b>24</b>
	<b>162 125x30 K</b>		<b>125</b>	<b>51</b>	<b>30</b>
	<b>520 125x24 K</b>	Mikrofaserleder microfiber leather discs cuir de microfibre cuero de microfibra pelle in microfibra	<b>125</b>	<b>51</b>	<b>24</b>
	<b>520 125x30 K</b>		<b>125</b>	<b>51</b>	<b>30</b>

	Art.Nr. art.No.	Material material	Ø mm	B mm	F mm	LZ
	<b>160 125x24 K</b>	Grobes Baumwollgewebe coarse cotton fabric toile de coton dur tejido de algodón grueso tessuto di cotone grossolano	<b>125</b>	<b>51</b>	<b>24</b>	
	<b>160 125x30 K</b>		<b>125</b>	<b>51</b>	<b>30</b>	
	<b>COSIMA Soft</b>	Weiches silikoniertes Baumwollgewebe soft silicon coated cotton fabric tissu de coton doux et siliconé tejido blando de algodón siliconado tessuto di cotone siliconato morbido				
	<b>869 125x24 K</b>		<b>125</b>	<b>51</b>	<b>24</b>	
	<b>869 125x30 K</b>		<b>125</b>	<b>51</b>	<b>30</b>	
	<b>COSIMA</b>	Silikoniertes Baumwollgewebe silicon coated cotton fabric tissu de coton siliconé tejido de algodón siliconado tessuto di cotone siliconato				
	<b>870 125x24 K</b>		<b>125</b>	<b>51</b>	<b>24</b>	
	<b>870 125x30 K</b>		<b>125</b>	<b>51</b>	<b>30</b>	
	<b>169 125/90 K</b>	Inletschwabbel fine cloth discs brosse avec toile fine cepillo de tela fina spazzola in tela fine	<b>125</b>	<b>51</b>	<b>19</b>	<b>90</b>
	<b>169 150/90 K</b>		<b>150</b>	<b>51</b>	<b>19</b>	<b>90</b>
	<b>167 100/10 K</b>	Nesselfaltschwabbel muslin discs slight pleats brosse en mousseline avec plis discos de muselina con arrugas spazzola in mussola arricciata	<b>100</b>	<b>42</b>	<b>10</b>	<b>10</b>
	<b>167 100/20 K</b>		<b>100</b>	<b>42</b>	<b>22</b>	<b>20</b>
	<b>167 100/30 K</b>		<b>100</b>	<b>51</b>	<b>33</b>	<b>30</b>
	<b>ZETA</b>	Microfaser microfiber microfibre microfibra microfibra				
	<b>862 125 x 20 K</b>		<b>125</b>	<b>50</b>	<b>20</b>	<b>50</b>

	Art.Nr. art.No.	Material material	Ø mm	B mm	F mm
	<b>156 50 H</b>		50	20	15
	<b>156 60 H</b>		60	25	17
	<b>156 70 H</b>		70	28	18
	<b>156 80 H</b>	Baumwollmullen mit Holzkern cotton buffs with wooden core grosse brosse en coton avec centre en bois cepillo con centro de madera filo di cotone con centro in legno	80	33	23
	<b>156 90 H</b>		90	35	20
	<b>156 100 H</b>		100	40	20
		<b>156 80/6 HS</b>	sehr feiner Faden very fine thread fil de coton très fin hilo de algodón muy fino filo di cotone molto fine	80	40
<b>156 80/4 HS</b>			80	40	27
 <b>150 80 BW</b>		grober Faden coarse cotton thread fil de coton dur hilo de algodón grueso filo di cotone grosso	80	40	18
 <b>152 80 BW</b>		feiner Faden fine thread fil de coton fin hilo de algodón fino filo di cotone fine	80	40	18

**MIRA Schwabbeln**  
**MIRA Buffs**  
**Disques MIRA**  
**Discos MIRA**  
**Spazzole MIRA**

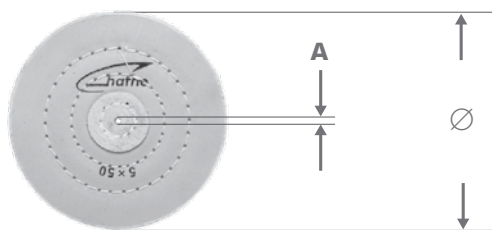

A = 6 mm (Standard) oder/or A = 15 mm



LZ = Lagenzahl  
 number of layers  
 nombre de disques  
 numero de hiladas  
 numero dei dischi

**H**  
 ungenäht · unstitched  
 non cousue · no cosido  
 non cucito

**HG**  
 genäht · stitched  
 cousue · cosido  
 cucito

2" / 3" / 4" = ∅ 2.800

5" / 6" = ∅ 1.400



		Art.Nr. art.No.	Material material	∅ mm	F mm	LZ	
		<b>661 4"x 50 H</b>	grober Baumwollstoff coarse cotton cloth tissu de coton dur tela de algodón grueso tessuto di cotone grossolano	100	13	50	
		<b>661 4"x 50 HG</b>		100	13	50	
		<b>661 6"x 50 H</b>		150	13	50	
		<b>661 6"x 50 HG</b>		150	13	50	
		<b>867 2"x 50 HG</b>		gelb getränkter feiner Baumwollstoff yellow treated fine cotton cloth tissu de coton imprégné jaune tela de algodón fina con teñido de amarillo tessuto di cotone fine impregnato di colore giallo	50	15	50
		<b>867 3"x 50 HG</b>			75	15	50
		<b>867 4"x 50 H</b>			100	15	50
		<b>867 4"x 50 HG</b>			100	15	50
		<b>867 5"x 50 HG</b>	125		15	50	
		<b>867 6"x 50 H</b>	150		15	50	
		<b>867 6"x 50 HG</b>	150		15	50	
	<b>867 6"x 60 HG</b>	150	15	60			
		<b>868 4"x 50 H</b>	feiner Baumwollstoff fine cotton cloth tissu de coton fin tela de algodón fina tela di cotone fine	100	15	50	
		<b>868 4"x 50 HG</b>		100	15	50	
		<b>868 5"x 50 HG</b>		125	15	50	
		<b>868 6"x 50 H</b>		150	15	50	
		<b>868 6"x 75 H</b>		150	15	75	
		<b>868 6"x 50 HG</b>		150	15	50	
	<b>868 6"x 60 HG</b>	150	15	60			



**HABRAS Bürsten, HABRAS Disc  
HABRAS Brushes, HABRAS Disc  
Brosses HABRAS, HABRAS Disc  
Cepillos HABRAS, HABRAS Disc  
HABRAS Spazzole, HABRAS Disc**

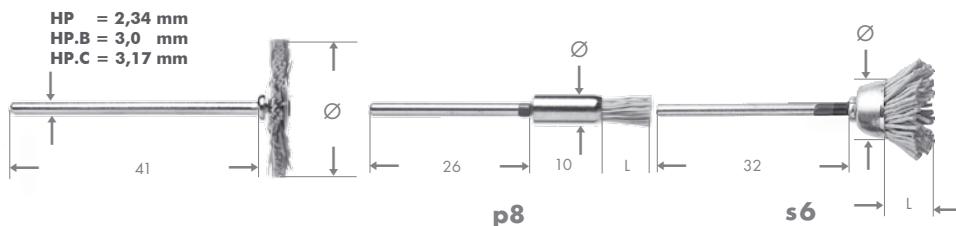

Besatzmaterial: Polyamidfaser mit eingebettetem Schleifkorn  
filling material: abrasive filament  
matériel de garniture: fil de polyamide avec grain abrasif  
guarnición: fibra de poliamida incluido el grano  
materiale utilizzato: fibra di poliammide con grana abrasive incorporate

10.000

	Ø mm	L mm	Korn grit	HP	HP.B	HP.C
	10	6	<b>AO fein fine fin fino fine</b> <b>600</b> Ø 0,30	400 s6 HP	400 s6 HPB	400 s6 HRC
	19			400 19 HP	400 19 HPB	400 19 HRC
	22			400 22 HP	400 22 HPB	400 22 HRC
	25			400 25 HP	400 25 HPB	400 25 HRC
	5	8		400 p8 HP	400 p8 HPB	400 e8 HRC
	10	6	<b>AO mittel medium medium medio media</b> <b>500</b> Ø 0,50	402 s6 HP	402 s6 HPB	402 s6 HRC
	19			402 19 HP	402 19 HPB	402 19 HRC
	22			402 22 HP	402 22 HPB	402 22 HRC
	25			402 25 HP	402 25 HPB	402 25 HRC
	5	8		402 p8 HP	402 p8 HPB	402 e8 HRC
	10	6	<b>AO grob coarse dur grueso grossa</b> <b>320</b> Ø 0,50	404 s6 HP	404 s6 HPB	404 s6 HRC
	19			404 19 HP	404 19 HPB	404 19 HRC
	22			404 22 HP	404 22 HPB	404 22 HRC
	25			404 25 HP	404 25 HPB	404 25 HRC
	5	8		404 p8 HP	404 p8 HPB	404 e8 HRC
	10	6	<b>SIC extra fein extra fine extra fin extra fino extra fine</b> <b>800</b> Ø 0,25	800 s6 HP	800 s6 HPB	800 s6 HRC
	19			800 19 HP	800 19 HPB	800 19 HRC
	22			800 22 HP	800 22 HPB	800 22 HRC
	25			800 25 HP	800 25 HPB	800 25 HRC
	5	8		800 p8 HP	800 p8 HPB	800 e8 HRC
	10	6	<b>SIC mittel medium medium medio media</b> <b>500</b> Ø 0,50	410 s6 HP	410 s6 HPB	410 s6 HRC
	19			410 19 HP	410 19 HPB	410 19 HRC
	22			410 22 HP	410 22 HPB	410 22 HRC
	25			410 25 HP	410 25 HPB	410 25 HRC
	5	8		410 p8 HP	410 p8 HPB	410 e8 HRC
	10	6	<b>SIC grob coarse dur grueso grossa</b> <b>320</b> Ø 0,56	420 s6 HP	420 s6 HPB	420 s6 HRC
	19			420 19 HP	420 19 HPB	420 19 HRC
	22			420 22 HP	420 22 HPB	420 22 HRC
	25			420 25 HP	420 25 HPB	420 25 HRC
	5	8		420 p8 HP	420 p8 HPB	420 e8 HRC



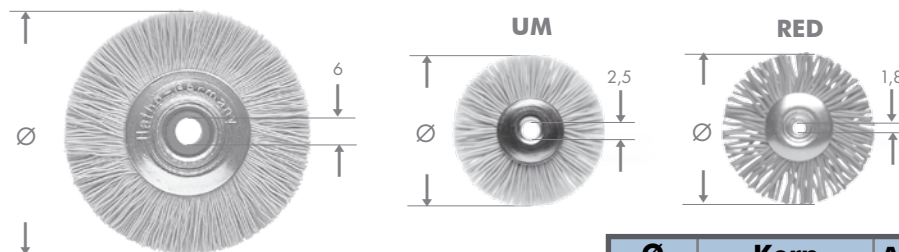



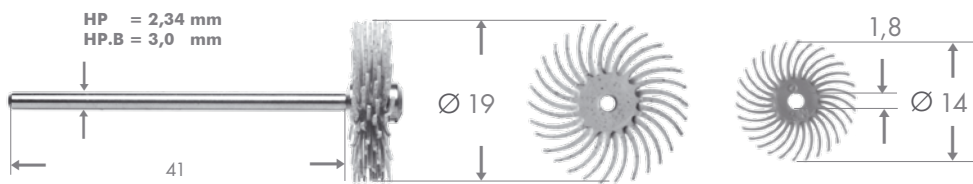

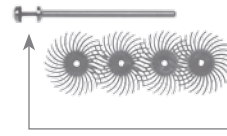

		Ø mm	Korn grit	Art.Nr. art.No.		
		19	<b>AO</b> fein fine fin fino fine  <b>600</b> Ø 0,30	400 19 UM		
		22		400 22 UM		
		42		400 42		
		51		400 51		
		22	400 22 RED			
		19	<b>AO</b> mittel medium medium medio media  <b>500</b> Ø 0,50	402 19 UM		
		22		402 22 UM		
		42		402 42		
		51		402 51		
		22	402 22 RED			
		19	<b>AO</b> grob coarse dur grueso grossa  <b>320</b> Ø 0,50	404 19 UM		
		22		404 22 UM		
		42		404 42		
		51		404 51		
		22	404 22 RED			
		19	<b>SIC</b> extra fein extra fine extra fin extra fino extra fine  <b>800</b> Ø 0,25	800 19 UM		
		22		800 22 UM		
		42		800 42		
		51		800 51		
		22	800 22 RED			
		19	<b>SIC</b> mittel medium medium medio media  <b>500</b> Ø 0,50	410 19 UM		
		22		410 22 UM		
		42		410 42		
		51		410 51		
		22	410 22 RED			
		19	<b>SIC</b> grob coarse dur grueso grossa  <b>320</b> Ø 0,56	420 19 UM		
		22		420 22 UM		
		42		420 42		
		51		420 51		
		22	420 22 RED			



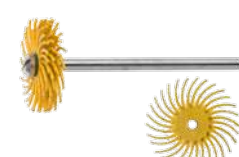

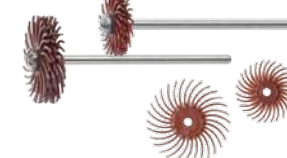
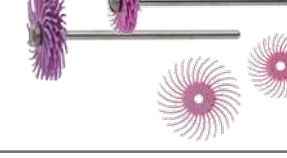

**Kunststoffscheibe mit eingebettetem Schleifkorn**  
**Acrylic disc with embedded abrasives**  
**Disque en plastique avec grain abrasif intégré**  
**Disco de plástico con grano incluido**  
**Disco in plastica con grana incorporata**

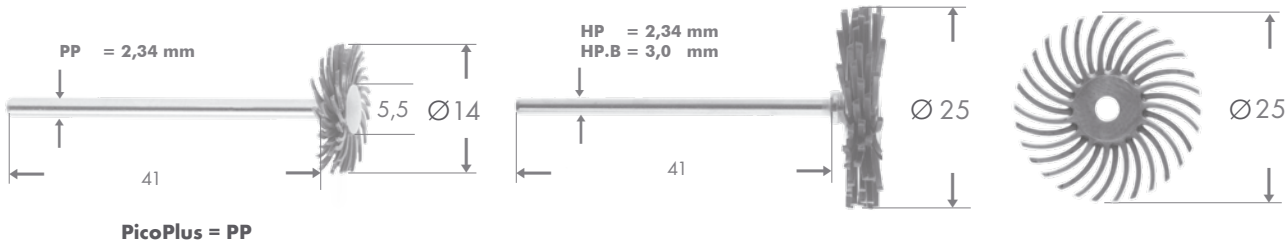

		Körnung grit	Charakter character	5.000	 Ø 14 mm	 Ø 19 mm											
901	Korund Corundum Corindon Corindón Corindone	grob coarse dur grueso grossa	80			901 19 HP 901 19 HRB 901 19 R/4 901 19 R/48											
						905	mittel medium medium medio media	120		905 14 HP 905 14 HRB 905 14 R/4 905 14 R/48	905 19 HP 905 19 HRB 905 19 R/4 905 19 R/48						
												902	standard standard standard estándar standard	220		902 14 HP 902 14 HRB 902 14 R/4 902 14 R/48	902 19 HP 902 19 HRB 902 19 R/4 902 19 R/48
904	Bimsstein Pumice Pierre ponce Pómez Pomice	sehr fein very fine très fin muy fino molto fine			904 14 HP 904 14 HRB 904 14 R/4 904 14 R/48	904 19 HP 904 19 HRB 904 19 R/4 904 19 R/48											
906	Edelkorund High grade corundum Corindon de haute qualité	extra fein extra fine extra fin extra fino extra fine	6 µm			906 19 HP 906 19 HRB 906 19 R/4 906 19 R/48											
907	Corindón especial Corindone di qualità	ultra fein ultra fine ultra fin ultra fino ultra fine	1 µm		907 14 HP 907 14 HRB 907 14 R/4 907 14 R/48	907 19 HP 907 19 HRB 907 19 R/4 907 19 R/48											





			5.000	Ø 14 mm
<b>905</b>	Korund Corundum Corindon Corindón Corindone	<b>mittel</b> medium medio media	<b>120</b>	 <b>905.1 14 PP</b>
<b>903</b>		<b>fein</b> fine fin fino fine	<b>400</b>	 <b>903.2 14 PP</b>
<b>904</b>	Bimsstein Pumice Pierre ponce Pómez Pomice	<b>sehr fein</b> very fine très fin muy fino molto fine		 <b>904.3 14 PP</b>



HABRAS Disc Pro DCS Kit 14









HP



R/4



R/48

			5.000	Ø 25 mm
<b>909</b>	Korund Corundum Corindon Corindón Corindone	<b>extra grob</b> extra coarse extra dur extra grueso extra grossa	<b>36</b>	 <b>909 25(3)HP</b> <b>909 25(3)HRB</b> <b>909 25 R/4</b> <b>909 25 R/48</b>
<b>908</b>		<b>sehr grob</b> very coarse très dur muy grueso molto grossa	<b>50</b>	 <b>908 25(3)HP</b> <b>908 25(3)HRB</b> <b>908 25 R/4</b> <b>908 25 R/48</b>
<b>901</b>		<b>grob</b> coarse dur grueso grossa	<b>80</b>	 <b>901 25(3)HP</b> <b>901 25(3)HRB</b> <b>901 25 R/4</b> <b>901 25 R/48</b>
<b>905</b>		<b>mittel</b> medium medio media	<b>120</b>	 <b>905 25(3)HP</b> <b>905 25(3)HRB</b> <b>905 25 R/4</b> <b>905 25 R/48</b>
<b>902</b>		<b>standard</b> standard standard estándar standard	<b>220</b>	 <b>902 25(3)HP</b> <b>902 25(3)HRB</b> <b>902 25 R/4</b> <b>902 25 R/48</b>
<b>903</b>		<b>fein</b> fine fin fino fine	<b>400</b>	 <b>903 25(3)HP</b> <b>903 25(3)HRB</b> <b>903 25 R/4</b> <b>903 25 R/48</b>



HABRAS Discs Kit 14

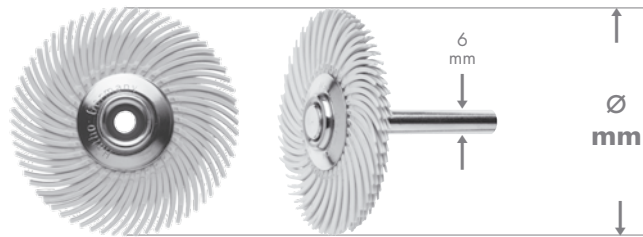

HABRAS Discs Kit 19

 1.400

	Art.Nr. art.No.	Ø mm	Körnung	Charakter character		
	<b>901 76x4</b>	<b>76</b>	Korund Corundum Corindon Corindón Corindone	<b>80</b>  <b>grob</b> <b>coarse</b> <b>dur</b> <b>grueso</b> <b>grossa</b>		
	<b>901 51x4</b>	<b>51</b>				
	<b>901 76x4 HR6</b>	<b>76</b>				
	<b>901 51x4 HR6</b>	<b>51</b>				
	<b>905 76x4</b>	<b>76</b>			Korund Corundum Corindon Corindón Corindone	<b>120</b>  <b>mittel</b> <b>medium</b> <b>medio</b> <b>media</b>
	<b>905 51x4</b>	<b>51</b>				
	<b>905 76x4 HR6</b>	<b>76</b>				
	<b>905 51x4 HR6</b>	<b>51</b>				
	<b>902 76x4</b>	<b>76</b>	Korund Corundum Corindon Corindón Corindone	<b>220</b>  <b>standard</b> <b>standard</b> <b>standard</b> <b>estándar</b> <b>standard</b>		
	<b>902 51x4</b>	<b>51</b>				
	<b>902 76x4 HR6</b>	<b>76</b>				
	<b>902 51x4 HR6</b>	<b>51</b>				





1.400



	Art.Nr. art.No.	Ø mm	Körnung grit	Charakter character
	903 76x4	76	Korund Corundum Corindon Corindón Corindone <b>400</b>	fein fine fin fino fine
	903 51x4	51		
	903 76x4 HP6	76		
	903 51x4 HP6	51		
	904 76x4	76	Bimsstein Pumice Pierre ponce Pómez Pomice	sehr fein very fine très fin muy fino molto fine
	904 51x4	51		
	904 76x4 HP6	76		
	904 51x4 HP6	51		
	906 76x4	76	Edelkorund High grade corundum Corindon de haute qualité Corindón especial Corindone di qualità	extra fein extra fine extra fin extra fino extra fine
	906 51x4	51		
	906 76x4 HP6	76	<b>6µm</b>	
	906 51x4 HP6	51		
	907 76x4	76	Edelkorund High grade corundum Corindon de haute qualité Corindón especial Corindone di qualità	ultra fein ultra fine ultra fin ultra fino ultra fine
	907 51x4	51		
	907 76x4 HP6	76	<b>1µm</b>	
	907 51x4 HP6	51		



**Miniaturbürsten**  
**Miniature Brushes**  
**Brossettes Miniatures**  
**Cepillos Miniaturas**  
**Spazzole Miniatur**

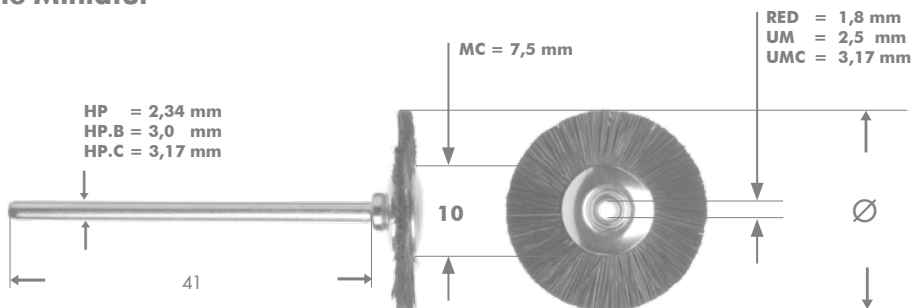















Besatzmaterial  
 filling material  
 matériel de garniture  
 guarnición  
 materiale utilizzato 10.000



	Ø	HP	HP.B	HP.C		RED	UM	UMC
<b>weißes Ziegenhaar · white goat hair · poils de chèvre blancs · pelo de cabra blanco · pelo di capra bianco</b>								
	16	100 16 HP	100 16 HP.B	100 16 HP.C		100 16 RED	100 16 UM	100 16 UMC
	19	100 19 HP	100 19 HP.B	100 19 HP.C		100 19 RED	100 19 UM	100 19 UMC
	22	100 22 HP	100 22 HP.B	100 22 HP.C		100 22 RED	100 22 UM	100 22 UMC
<b>graus Ziegenhaar · grey goat hair · poils de chèvre gris · pelo de cabra gris · pelo di capra grigio</b>								
	16	102 16 HP	102 16 HP.B	102 16 HP.C		102 16 RED	102 16 UM	102 16 UMC
	19	102 19 HP	102 19 HP.B	102 19 HP.C		102 19 RED	102 19 UM	102 19 UMC
	22	102 22 HP	102 22 HP.B	102 22 HP.C		102 22 RED	102 22 UM	102 22 UMC
<b>graus Pferdehaar · grey horse hair · crins de cheval gris · crin de caballo gris · crine di cavallo grigio</b>								
	16	112 16 HP	112 16 HP.B	112 16 HP.C		112 16 RED	112 16 UM	112 16 UMC
	19	112 19 HP	112 19 HP.B	112 19 HP.C		112 19 RED	112 19 UM	112 19 UMC
	22	112 22 HP	112 22 HP.B	112 22 HP.C		112 22 RED	112 22 UM	112 22 UMC
<b>weiße Chungking Borsten · white Chungking bristles · soie de Tchong King blanche · cerda de Chung King blanca · setola di Chungking bianca</b>								
	16	120 16 HP	120 16 HP.B	120 16 HP.C		120 16 RED	120 16 UM	120 16 UMC
	19	120 19 HP	120 19 HP.B	120 19 HP.C		120 19 RED	120 19 UM	120 19 UMC
	22	120 22 HP	120 22 HP.B	120 22 HP.C		120 22 RED	120 22 UM	120 22 UMC
<b>schwarze Chungking Borsten · black Chungking bristles · soie de Tchong King noire · cerda de Chung King negra · setola di Chungking nera</b>								
	16	121 16 HP	121 16 HP.B	121 16 HP.C		121 16 RED	121 16 UM	121 16 UMC
	19	121 19 HP	121 19 HP.B	121 19 HP.C		121 19 RED	121 19 UM	121 19 UMC
	22	121 22 HP	121 22 HP.B	121 22 HP.C		121 22 RED	121 22 UM	121 22 UMC
<b>weißes Ziegenhaar · white goat hair · poils de chèvre blancs · pelo de cabra blanco · pelo di capra bianco</b>								
	16	100 16 (MC) HP	100 16 (MC) HP.B		100 16 (MC) UM			
	19	100 19 (MC) HP	100 19 (MC) HP.B		100 19 (MC) UM			
<b>graus Ziegenhaar · grey goat hair · poils de chèvre gris · pelo de cabra gris · pelo di capra grigio</b>								
	16	102 16 (MC) HP	102 16 (MC) HP.B		102 16 (MC) UM			
	19	102 19 (MC) HP	102 19 (MC) HP.B		102 19 (MC) UM			
<b>weiße Chungking Borsten · white Chungking bristles · soie de Tchong King blanche · cerda de Chung King blanca · setola di Chungking bianca</b>								
	16	120 16 (MC) HP	120 16 (MC) HP.B		120 16 (MC) UM			
	19	120 19 (MC) HP	120 19 (MC) HP.B		120 19 (MC) UM			
<b>schwarze Chungking Borsten · black Chungking bristles · soie de Tchong King noire · cerda de Chung King negra · setola di Chungking nera</b>								
	16	121 16 (MC) HP	121 16 (MC) HP.B		121 16 (MC) UM			
	19	121 19 (MC) HP	121 19 (MC) HP.B		121 19 (MC) UM			

















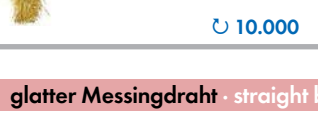

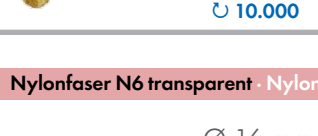



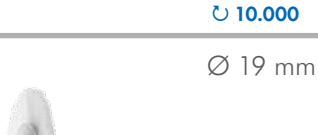

Besatzmaterial  
filling material  
matériel de garniture  
guarnición  
materiale utilizzato

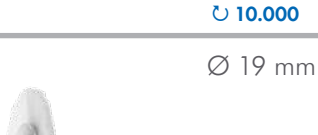
	Draht wire Ø	HP	HP.B	HP.C		RED	UM	UMC
<b>gewellter Stahldraht · crimped steel wire · fil d'acier ondulé · alambre de acero ondulado · filo d'acciaio ondulato</b>								
 Ø 16 mm ↻ 15.000	0,08	192 16 HP	192 16 HP.B	192 16 HP.C		192 16 RED	192 16 UM	192 16 UMC
	0,10	193 16 HP	193 16 HP.B	193 16 HP.C		193 16 RED	193 16 UM	193 16 UMC
	0,12	194 16 HP	194 16 HP.B	194 16 HP.C		194 16 RED	194 16 UM	194 16 UMC
 Ø 19 mm ↻ 12.000	0,08	192 19 HP	192 19 HP.B	192 19 HP.C		192 19 RED	192 19 UM	192 19 UMC
	0,10	193 19 HP	193 19 HP.B	193 19 HP.C		193 19 RED	193 19 UM	193 19 UMC
	0,12	194 19 HP	194 19 HP.B	194 19 HP.C		194 19 RED	194 19 UM	194 19 UMC
 Ø 22 mm ↻ 10.000	0,08	192 22 HP	192 22 HP.B	192 22 HP.C		192 22 RED	192 22 UM	192 22 UMC
	0,10	193 22 HP	193 22 HP.B	193 22 HP.C		193 22 RED	193 22 UM	193 22 UMC
	0,12	194 22 HP	194 22 HP.B	194 22 HP.C		194 22 RED	194 22 UM	194 22 UMC
<b>gewellter Edelstahldraht · crimped stainless steel wire · fil d'acier inoxydable ondulé · alambre de acero inoxidable ondulado · filo d'acciaio inossidabile ondulato</b>								
 Ø 16 mm ↻ 15.000	0,06	181 16 HP	181 16 HP.B	181 16 HP.C		181 16 RED	181 16 UM	181 16 UMC
	0,08	182 16 HP	182 16 HP.B	182 16 HP.C		182 16 RED	182 16 UM	182 16 UMC
	0,10	183 16 HP	183 16 HP.B	183 16 HP.C		183 16 RED	183 16 UM	183 16 UMC
	0,12	184 16 HP	184 16 HP.B	184 16 HP.C		184 16 RED	184 16 UM	184 16 UMC
 Ø 19 mm ↻ 12.000	0,06	181 19 HP	181 19 HP.B	181 19 HP.C		181 19 RED	181 19 UM	181 19 UMC
	0,08	182 19 HP	182 19 HP.B	182 19 HP.C		182 19 RED	182 19 UM	182 19 UMC
	0,10	183 19 HP	183 19 HP.B	183 19 HP.C		183 19 RED	183 19 UM	183 19 UMC
	0,12	184 19 HP	184 19 HP.B	184 19 HP.C		184 19 RED	184 19 UM	184 19 UMC
 Ø 22 mm ↻ 10.000	0,06	181 22 HP	181 22 HP.B	181 22 HP.C		181 22 RED	181 22 UM	181 22 UMC
	0,08	182 22 HP	182 22 HP.B	182 22 HP.C		182 22 RED	182 22 UM	182 22 UMC
	0,10	183 22 HP	183 22 HP.B	183 22 HP.C		183 22 RED	183 22 UM	183 22 UMC
	0,12	184 22 HP	184 22 HP.B	184 22 HP.C		184 22 RED	184 22 UM	184 22 UMC
<b>glatter Edelstahldraht · straight brass wire · fil d'acier inoxydable lisse · alambre de acero inoxidable liso · filo d'acciaio inossidabile liscio</b>								
 Ø 22 mm ↻ 10.000	0,08	682 22 HP	682 22 HP.B	682 22 HP.C		682 22 RED	682 22 UM	



Besatzmaterial  
filling material  
matériel de garniture  
guarnición  
materiale utilizzato

	Draht wire Ø	HP	HP.B	HP.C		RED	UM	UMC
<b>gewellter Messingdraht · crimped brass wire · fil de laiton ondulé · alambre de latón ondulado · filo di ottone ondulato</b>								
 Ø 16 mm   Ø 15.000	<b>0,06</b>	141 16 HP	141 16 HP.B	141 16 HP.C		141 16 RED	141 16 UM	141 16 UMC
	<b>0,08</b>	142 16 HP	142 16 HP.B	142 16 HP.C		142 16 RED	142 16 UM	142 16 UMC
	<b>0,10</b>	143 16 HP	143 16 HP.B	143 16 HP.C		143 16 RED	143 16 UM	143 16 UMC
	<b>0,12</b>	144 16 HP	144 16 HP.B	144 16 HP.C		144 16 RED	144 16 UM	144 16 UMC
 Ø 19 mm   Ø 12.000	<b>0,06</b>	141 19 HP	141 19 HP.B	141 19 HP.C		141 19 RED	141 19 UM	141 19 UMC
	<b>0,08</b>	142 19 HP	142 19 HP.B	142 19 HP.C		142 19 RED	142 19 UM	142 19 UMC
	<b>0,10</b>	143 19 HP	143 19 HP.B	143 19 HP.C		143 19 RED	143 19 UM	143 19 UMC
	<b>0,12</b>	144 19 HP	144 19 HP.B	144 19 HP.C		144 19 RED	144 19 UM	144 19 UMC
 Ø 22 mm   Ø 10.000	<b>0,06</b>	141 22 HP	141 22 HP.B	141 22 HP.C		141 22 RED	141 22 UM	141 22 UMC
	<b>0,08</b>	142 22 HP	142 22 HP.B	142 22 HP.C		142 22 RED	142 22 UM	142 22 UMC
	<b>0,10</b>	143 22 HP	143 22 HP.B	143 22 HP.C		143 22 RED	143 22 UM	143 22 UMC
	<b>0,12</b>	144 22 HP	144 22 HP.B	144 22 HP.C		144 22 RED	144 22 UM	144 22 UMC
<b>glatter Messingdraht · straight brass wires · fil de laiton lisse · alambre de latón liso · filo di ottone liscio</b>								
 Ø 19 mm   Ø 22 mm  Ø 10.000	<b>0,08</b>	642 19 HP	642 19 HP.B	642 19 HP.C		642 19 RED	642 19 UM	
	<b>0,08</b>	642 22 HP	642 22 HP.B	642 22 HP.C		642 22 RED	642 22 UM	
<b>Nylonfaser N6 transparent · Nylon filament N6 transparent · fibres de nylon N6 transparent · fibra de nylon N6 transparente · fibra di nylon N6 trasparente</b>								
 Ø 16 mm   Ø 19 mm   Ø 22 mm  Ø 5.000	<b>0,15</b>	282 16 HP	282 16 HP.B	282 16 HP.C		282 16 RED	282 16 UM	282 16 UMC
	<b>0,20</b>	283 16 HP	283 16 HP.B	283 16 HP.C		283 16 RED	283 16 UM	283 16 UMC
	<b>0,25</b>	284 16 HP	284 16 HP.B	284 16 HP.C		284 16 RED	284 16 UM	284 16 UMC
	<b>0,30</b>	286 16 HP	286 16 HP.B	286 16 HP.C		286 16 RED	286 16 UM	286 16 UMC
	<b>0,40</b>	288 16 HP	288 16 HP.B	288 16 HP.C		288 16 RED	288 16 UM	288 16 UMC
 Ø 19 mm   Ø 22 mm  Ø 5.000	<b>0,15</b>	282 19 HP	282 19 HP.B	282 19 HP.C		282 19 RED	282 19 UM	282 19 UMC
	<b>0,20</b>	283 19 HP	283 19 HP.B	283 19 HP.C		283 19 RED	283 19 UM	283 19 UMC
	<b>0,25</b>	284 19 HP	284 19 HP.B	284 19 HP.C		284 19 RED	284 19 UM	284 19 UMC
	<b>0,30</b>	286 19 HP	286 19 HP.B	286 19 HP.C		286 19 RED	286 19 UM	286 19 UMC
	<b>0,40</b>	288 19 HP	288 19 HP.B	288 19 HP.C		288 19 RED	288 19 UM	288 19 UMC
 Ø 22 mm  Ø 5.000	<b>0,15</b>	282 22 HP	282 22 HP.B	282 22 HP.C		282 22 RED	282 22 UM	282 22 UMC
	<b>0,20</b>	283 22 HP	283 22 HP.B	283 22 HP.C		283 22 RED	283 22 UM	283 22 UMC
	<b>0,25</b>	284 22 HP	284 22 HP.B	284 22 HP.C		284 22 RED	284 22 UM	284 22 UMC
	<b>0,30</b>	286 22 HP	286 22 HP.B	286 22 HP.C		286 22 RED	286 22 UM	286 22 UMC
	<b>0,40</b>	288 22 HP	288 22 HP.B	288 22 HP.C		288 22 RED	288 22 UM	288 22 UMC

**GEZA Bürsten**  
**GEZA Brushes**  
**Brosses GEZA**  
**Cepillos GEZA**  
**Spazzole GEZA**

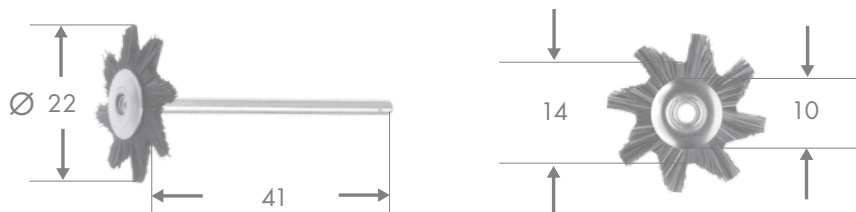

**Besatzmaterial**  
**filling material**  
**matériel de garniture**  
**guarnición**  
**materiale utilizzato**

10.000

10.000

weißes Ziegenhaar white goat hair poils de chèvre blancs pelo de cabra blanco pelo di capra bianco		GEZA 100 HP		GEZA 100 UM	
weiße Chungking Borsten white Chungking bristles soie de Tchong King blanche cerda de Chung King blanca setola die Chungking bianca		GEZA 120 HP		GEZA 120 UM	
schwarze Chungking Borsten black Chungking bristles soie de Tchong King noire cerda de Chung King negra setola die Chungking nera		GEZA 121 HP		GEZA 121 UM	
graue Chungking Borsten grey Chungking bristles soie de Tchong King gris cerda de Chung King gris setola die Chungking grigia		GEZA 122 HP		GEZA 122 UM	



**Kombi Bürsten**  
**Kombi Brushes**  
**Brosses Kombi**  
**Cepillos Kombi**  
**Spazzole Kombi**

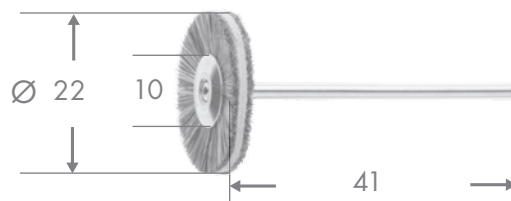

10.000

10.000

weißes Ziegenhaar / Leder white goat hair / leather poils de chèvre blancs / peau de chamois pelo de cabra blanco / cuero de gamuza pelo di capra bianco / pelle di camoscio		100/500 22 HP		graues Ziegenhaar / Leder grey goat hair / leather poils de chèvre gris / peau de chamois pelo de cabra gris / cuero de gamuza pelo di capra grigio / pelle di camoscio	102/500 22 HP
weißes Ziegenhaar / Mikrofaser- Leder white goar hair / microfiber- leather poils de chèvre blancs / cuir synthétique pelo de cabra blanca / cuero de microfibra pelo di capra bianco / pelle in microfibra		100/520 22 HP		graues Ziegenhaar / Mikro- faser-Leder grey goat hair / microfiber- leather poils de chèvre gris/ cuir synthétique pelo de cabra gris / cuero de microfibra pelo di capra grigio / pelle in microfibra	102/520 22 HP
weißes Ziegenhaar / ZETA Tuch white goat hair / ZETA cloth poils de chèvre blancs / tissu ZETA pelo de cabra blanco / paño ZETA pelo di capra bianco / panno ZETA		100/862 22 HP		graues Ziegenhaar / ZETA Tuch grey goat hair / ZETA cloth poils de chèvre gris / tissu ZETA pelo de cabra gris/ paño ZETA pelo di capra grigio / panno ZETA	102/862 22 HP



**TORO Bürsten**  
**TORO Brushes**  
**Brossettes TORO**  
**Cepillos TORO**  
**Spazzole TORO**

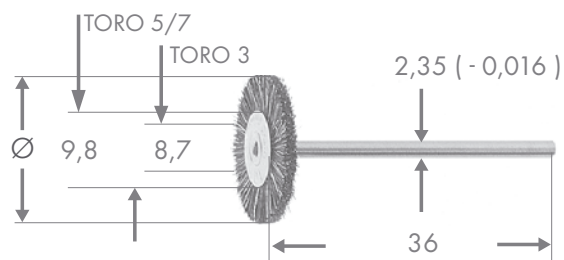

ISO Standard Schaft  
 ISO Standard Shank  
 Tige Standard ISO  
 Vástago ISO estándar  
 Mandrino standardizzato ISO

**Besatzmaterial**  
**filling material**  
**matériel de garniture**  
**guarnición**  
**materiale utilizzato**

10.000



	Ø mm	Ø inch	Art.Nr. art.No.
<b>weißes Ziegenhaar</b> white goat hair poils de chèvre blancs pelo de cabra blanco pelo di capra bianco	14,4	9/16	TORO 3 100
	17,5	11/16	TORO 5 100
	19	3/4	TORO 7 100
<b>graues Ziegenhaar</b> grey goat hair poils de chèvre gris pelo de cabra gris pelo di capra grigio	14,4	9/16	TORO 3 102
	17,5	11/16	TORO 5 102
	19	3/4	TORO 7 102
<b>silbergraues Pferdehaar</b> standard hard silvergrey horse hair standard hard crins de cheval gris argent standard dur crin de caballo gris argentado standard duro crine di cavallo grigio argentato standard duro	14,4	9/16	TORO 3 115
	17,5	11/16	TORO 5 115
	19	3/4	TORO 7 115
<b>Pferdehaar extra hart</b> horse hair extra hard crins de cheval extra dur crin de caballo extra duro crine di cavallo extra duro	14,4	9/16	TORO 3 114
	17,5	11/16	TORO 5 114
	19	3/4	TORO 7 114



**ASTRO Bürsten**  
**ASTRO Brushes**  
**Brossettes ASTRO**  
**Cepillos ASTRO**  
**Spazzole ASTRO**

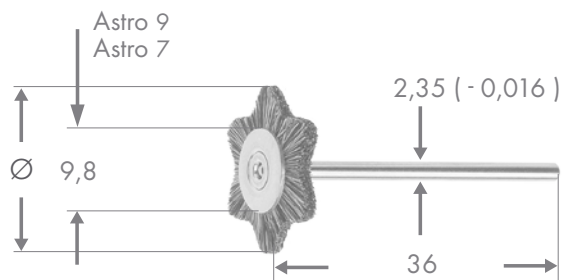

ISO Standard Schaft  
 ISO Standard Shank  
 Tige Standard ISO  
 Vástago ISO estándar  
 Mandrino standardizzato ISO

**Besatzmaterial**  
 filling material  
 matériel de garniture  
 guarnición  
 materiale utilizzato

10.000



	Ø mm	Ø inch	Art.Nr. art.No.
<b>weißes Ziegenhaar</b> white goat hair poils de chèvre blancs pelo de cabra blanco pelo di capra bianco	19	3/4	ASTRO 7 100
	22	7/8	ASTRO 9 100
<b>graues Ziegenhaar</b> grey goat hair poils de chèvre gris pelo de cabra gris pelo di capra grigio	19	3/4	ASTRO 7 102
	22	7/8	ASTRO 9 102
<b>silbergraues Pferdehaar standard hart</b> silvergry horse hair standard hard crins de cheval gris argent standard dur crin de caballo gris argentado standard duro crine di cavallo grigio argentato standard duro	19	3/4	ASTRO 7 115
	22	7/8	ASTRO 9 115
<b>Pferdehaar extra hart</b> horse hair extra hard crins de cheval extra dur crin de caballo extra duro crine di cavallo extra duro	19	3/4	ASTRO 7 114
	22	7/8	ASTRO 9 114



**Minischleifvliesräder mit Scotch Brite™**  
**Mini Trimming Wheels with Scotch Brite™**  
**Roues mini d'affilage en toison abrasive avec Scotch Brite™**  
**Micromuelas abrasivas Scotch Brite™**  
**Mini routine abrasive in Scotch Brite™**

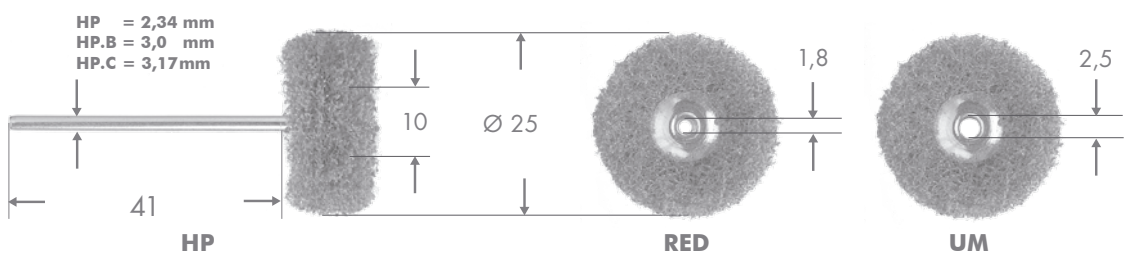

10.000

mesh	Art.Nr. art.No.	Art.Nr. art.No.	Korn grit	Charakter character	Color	
80	259 25 HP		SIC	extra grob extra coarse extra dur extra grueso extra grossa	Dunkel Braun Dark Brown Marron Foncé Marron oscuro Marrone scuro	
	259 25 HP.B					259 25 RED
	259 25 HP.C					259 25 UM
120	258 25 HP		SIC	super grob super coarse super dur super grueso super grossa	Schwarz Black Noir Negro Nero	
	258 25 HP.B					258 25 RED
	258 25 HP.C					258 25 UM
220	250 25 HP		AO	grob coarse dur grueso grossa	Braun Brown Marron Marron Marrone	
	250 25 HP.B					250 25 RED
	250 25 HP.C					250 25 UM
280	251 25 HP		SIC	mittel medium medium medio media	Grau Grey Gris Gris Grigio	
	251 25 HP.B					251 25 RED
	251 25 HP.C					251 25 UM
360	252 25 HP		AO	fein fine fin fino fine	Rot Red Rouge Rojo Rosso	
	252 25 HP.B					252 25 RED
	252 25 HP.C					252 25 UM
360	255 25 HP		AO	fein fine fin fino fine	Purpur Purple Violet Púrpura Viola	
	255 25 HP.B					255 25 RED
	255 25 HP.C					255 25 UM
400	257 25 HP		SIC	extra fein extra fine extra fin extra fino extra fine	Hellgrau Light Grey Gris clair Gris claro Grigio chiaro	
	257 25 HP.B					257 25 RED
	257 25 HP.C					257 25 UM
600	256 25 HP		AO	ultra fein ultra fine ultra fin ultra fino ultra fine	Kupfer Copper Cuivre Cobre Rame	
	256 25 HP.B					256 25 RED
	256 25 HP.C					256 25 UM
-	253 25 HP 253 25 HP.B 253 25 HP.C			ohne Schleifmittel without abrasive sans grain sin grano senza grana	Weiß White Blanc Blanco Bianca	
220	254 25 HP		AO	grob gebunden coarse unitized dur lié gruesa ligado grana grosso	Marmor Marble Marbre Mármol Marmo	
	254 25 HP.B					254 25 RED
	254 25 HP.C					254 25 UM

**Schleifvliesräder mit Scotch Brite™**  
**Trimming Wheels with Scotch Brite™**  
**Roues d'affilage en toison abrasive avec Scotch Brite™**  
**Muelas abrasivas Scotch Brite™**  
**Routine abrasive in Scotch Brite™**

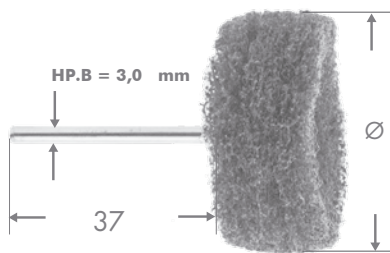

10.000

mesh

	Art.Nr. art.No.	Ø mm	Korn grit	Charakter character	Color
 <p><b>220</b></p>	250 40/3 HP.B	40	AO	grob coarse dur grueso grossa	Braun Brown Marron Marron Marrone
	250 30/3 HP.B	30			
 <p><b>280</b></p>	251 40/3 HP.B	40	SIC	mittel medium medium medio media	Grau Grey Gris Gris Grigio
	251 30/3 HP.B	30			
 <p><b>360</b></p>	451 40/3 HP.B	40	AO	mittel medium medium medio media	Rot-Braun Red Brown Rouge-marron Rojo marrón Rosso marrone
	451 30/3 HP.B	30			
 <p><b>360</b></p>	252 40/3 HP.B	40	AO	fein fine fin fino fine	Rot Red Rouge Rojo Rosso
	252 30/3 HP.B	30			
 <p><b>360</b></p>	255 40/3 HP.B	40	AO	fein fine fin fino fine	Purpur Purple Violet Púrpura Viola
	255 30/3 HP.B	30			



	240 25 R	25	AO	3 mm gepresst 3 mm pressed pressé à 3 mm 3 mm prensado pressato a 3 mm
---	----------	----	----	--



**Miniaturschwabbeln**  
**Miniature Polishing Discs**  
**Disques miniatures à polir**  
**Discos miniaturas de pulimento**  
**Dischi miniatur per lucidare**

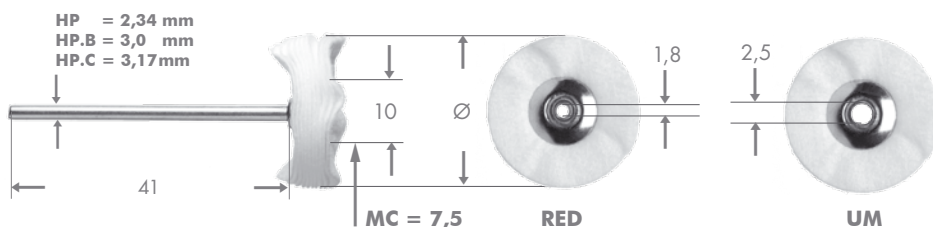



**Besatzmaterial**  
 filling material  
 matériel de garniture  
 guarnición  
 materiale utilizzato

grober Baumwollfaden coarse cotton thread fil de coton dur hilo de algodón grueso filo di cotone grosso Ø 22 mm 10.000	 normal voll normal thickness	 150 22 HP 150 22 HRB 150 22 HRC	 extra voll extra full 151 22 HP 151 22 HRB 151 22 HRC	
				 RED
				 UM



feiner Baumwollfaden fine cotton thread fil de coton fin hilo de algodón fino filo di cotone fine Ø 22 mm 10.000	 normal voll normal thickness 152 22 HP 152 22 HRB 152 22 HRC	 doppelt voll double thickness 153 22 HP 153 22 HRB 153 22 HRC	 extra voll extra full 154 22 HP 154 22 HRB 154 22 HRC	 doppelt extra voll double extra full 155 22 HP 155 22 HRB 155 22 HRC
--	---	--	---	---

silikonisiertes Baumwollgewebe silicon coated cotton fabric tissu de coton siliconé tejido de algodón siliconado tessuto di cotone siliconato Ø 22 mm 10.000	<b>COSIMA Soft</b> weich soft doux blando morbido  869 22 HP 869 22 HRB 869 22 HRC	 869 22 UM 869 22 RED	<b>COSIMA</b>  870 22 HP 870 22 HRB 870 22 HRC	 870 22 UM 870 22 RED
--	--	--	--	--

Baumwollgewebe verstärkt reinforced cotton fabric toile de coton et renforcé tejido de algodón reforzado tessuto di cotone rafforzato Ø 25 mm 10.000	<b>MIRA Mini</b>  867 25 HP 867 25 HRB 867 25 HRC	<b>MIRA Mini</b> genäht stitched cousue cosida cucito  867 25g HP 867 25g HRB 867 25g HRC	<b>MIRA Mini</b> genäht stitched cousue cosida cucito  867 25g R
--	--	---	---



Nessel Tuch muslin cloth mousseline muselina tela in mussola Ø 22 mm 10.000	 160 22 HP 160 22 UM	 160 16 (MC) HP 160 19 (MC) HP 160 22 (MC) HP	 160 16 (MC) HP 160 19 (MC) HP 160 22 (MC) HP	 160 19 (MC) HP 160 22 (MC) HP
---	---	---	--	---

Besatzmaterial  
filling material  
matériel de garniture  
guarnición  
materiale utilizzato





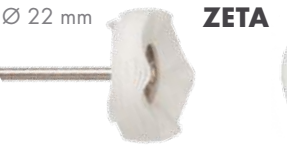

<p>Nesseltuch genäht muslin cloth stitched mousseline cousue muselina cosida tela cucita</p> <p>10.000</p>	<p>Ø 22 mm</p> 	<p>Ø 25 mm</p> 	<p>Ø 28 mm</p> 
	<p>160 22g HP 160 22g UM</p>	<p>160 25g HP 160 25g UM</p>	<p>160 28g HP</p>

<p>gebleichter Nesselstoff muslin cloth white disque de mousseline blanche cepillo de muselina blanqueada mussola tinta</p> <p>10.000</p>	<p>Ø 22 mm</p> 	<p>Ø 25 mm</p> 
	<p>164 22 HP 164 22 UM</p>	<p>164 25g HP</p>

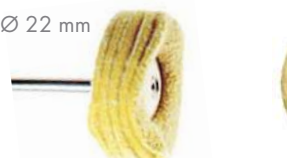
<p>Microfaser microfibre microfibre microfibre microfibra</p> <p>10.000</p>	<p>Ø 22 mm</p> 	<p><b>ZETA</b></p> 
	<p>862 22 HP 862 22 HRB 862 22 HRC</p>	<p>862 22 UM 862 22 RED</p>

<p>Wildleder chamois leather peau de chamois cuero de gamuza pelle di camoscio</p> <p>10.000</p>	<p>Ø 22 mm</p> 	<p>Ø 25 mm</p> 	
	<p>500 22 HP 500 22 HRB 500 22 HRC</p>	<p>500 22 UM 500 22 RED</p>	<p>500 25 HP 500 25 HRB 500 25 HRC</p>

<p>Mikrofaser-Leder microfibre leather cuir synthétique cuero de microfibra pelle in microfibra</p> <p>10.000</p>	<p>Ø 22 mm</p> 	
	<p>520 22 HP 520 22 HRB 520 22 HRC</p>	<p>520 22 UM 520 22 RED</p>

<p>Flanell flannell cloth flannelle franela flanella</p> <p>10.000</p>	<p>Ø 22 mm</p> 	
	<p>161 22 HP 161 22 HRB 161 22 HRC</p>	<p>161 22 UM 161 22 RED</p>

<p>Filztuch felt cloth toile de feutre tela de fieltro feltro</p> <p>10.000</p>	<p>Ø 22 mm</p> 	<p>Ø 25 mm</p> 	
	<p>162 22 HP 162 22 HRB 162 22 HRC</p>	<p>162 22 UM 162 22 RED</p>	<p>162 25 HP 162 25 HRB 162 25 HRC</p>





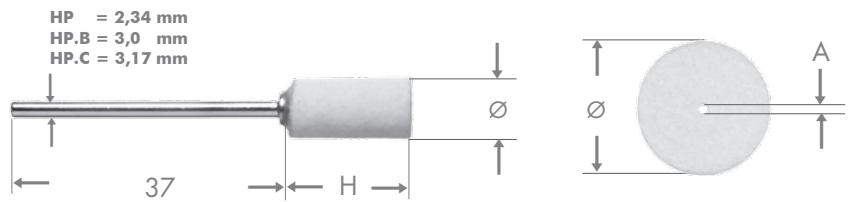





**Filzpolierkörper**  
**Felt polishers**  
**Feutres**  
**Filtros para pulir**  
**Feltri per lucidare**



D= Dichte Density Densité  
 Densidad Densitá

	<b>Art.Nr.</b> <b>art.No.</b>	<b>Ø</b> <b>mm</b>	<b>H</b> <b>mm</b>	<b>A</b> <b>mm</b>	<b>D</b>	
	173 15x20	15	20	4,2	hart hard dur duro duro	
	173 15x25	15	25			
	173 15x30	15	30	5,0		
	173 20x35	20	35			
	173 20x40	20	40			
	173 25x45	25	45	5,5		
	173 20x50	20	50			
	173 25x50	25	50			
173 30x60	30	60				
	174 12x3 036	12	3	1,8	weich/soft standard/standard extra weich/extra soft extra weich/extra soft standard/standard hart/hard weich/soft	
	174 21x4 056	21	4			
	174 25x4 028	25	4			
	174 25x5 028	25	5			
	174 25x5 056	25	5			
	174 25x5 065	25	5			
	174 25x6 030	25	6	3,0		
	174 25x8 056	25	8			
	174 30x10	30	10			
	174 40x10	40	10			
	174 50x10	50	10			
	174 60x13	60	13			
	174 80x20	80	20			
	174 80x25	80	25			
174 100x20	100	20				
	174 17 UM	17	4	2,5	weich soft doux blando morbido	
	174 19 UM	19	4			
	174 21 UM	21	4			
	174 25 UM	25	4			
	174 17 RED	17	4	1,8		
	174 19 RED	19	4			
	174 21 RED	21	4			
	175 12x3	12	3	1,8		hart hard dur duro duro
	175 17x4	17	4			
	175 19x4,5	19	4,5			
	175 21x5	21	5			
	175 25x7	25	7			
	175 30x7	30	7			
	175 40x10	40	10			
	175 50x10	50	10			
175 60x13	60	13				
	176 22x13 LL	22	13		standard standard standard estándar standard	
	176 25x16 ML	25	16			
	176 22x13 LS	22	13			
	176 25x16 MS	25	16			

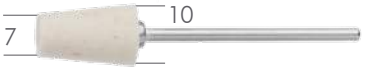

	Art.Nr. art.No.	Ø mm	H mm	D
	170 8 HP.B	8	14	extra hart extra hard extra dur extra duro extra duro
	170 8 HP	8	14	
	170 11 HP	11	16	
	171 10 HP	10	13	
	171 10 HP.B	10	13	
	171 12 HP	12	14	
	171 12 HP.B	12	14	
	172 4 HP	4	11	
	172 4 HP.B	4	11	
	172 6 HP	6	16	
	172 6 HP.B	6	16	
	172 8 HP	8	16	
	172 8 HP.B	8	16	
	172 10 HP	10	16	
	172 10 HP.B	10	16	
	172 12 HP	12	16	
	172 12 HP.B	12	16	
172 12 HP.C	12	16		
	173 6 HP	6	20	
	173 6 HP.B	6	20	
	173 8 HP	8	20	
	173 8 HP.B	8	20	
	173 9 HP	9	20	
	173 9 HP.B	9	20	
	173 11 HP	11	24	
	173 11 HP.B	11	24	
	174 17 HP.B	17	4	
	174 17 HP	17	4	
	174 19 HP	19	4	
	174 21 HP	21	4	
	174 21 HP.B	21	4	
	174 25 HP	25	4	
	174 25 HP.C	25	4	
	174 21x9 HP	21	10	
	174 25x10 HP	25	10	
	174 FL 20x10x1 HP	20	10	
	174 FL 20x10x1 HP.B	20	10	
	174 FL 20x10x1 HP.C	20	10	
	174 FL 30x20x4 HP	30	20	
174 FL 30x20x4 HP.B	30	20		
174 FL 30x20x4 HP.C	30	20		
	175 17 HP	17	5	
	175 17 HP.B	17	5	
	175 19 HP	19	5	
	175 19 HP.B	19	5	
	175 21 HP	21	5	
	175 21 HP.B	21	5	
	176 17 HP	17	5	
	176 19 HP	19	5	
	176 19 HP.B	19	5	
	176 21 HP	21	5	
	177 7x10 HP	10	16	
	177 7x10 HP.B	10	16	
	177 12x7 HP	12	16	
	177 12x7 HP.B	12	16	





## HATHOfex S plus P HATHOfex S plus P

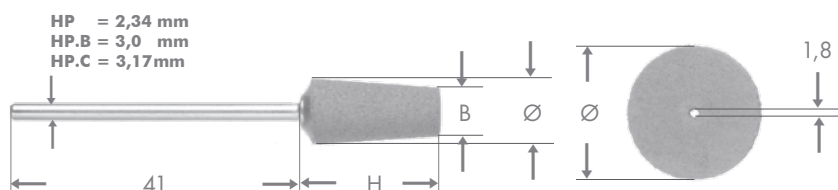

**Schleif- und Polierwerkzeuge aus elastisch gebundenem Korund**  
**Grinding and Polishing Instruments with elastic bonded corundum**  
**Meule à affiler et à polir avec corindon, lien élastique**  
**Herramientas de pulido de corindón elástico prensado**  
**Abrasivi e strumenti per lucidare in lega di corindone**

1:1





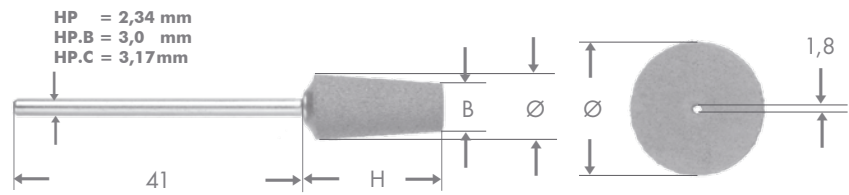





Form shape	Körnung grit	80	180	240	400	Ø mm	H mm	
 12.000	 12.000	204 20 R	214 20 R	224 20 R	234 20 R	20	3	
		204 20 UM	214 20 UM	224 20 UM	234 20 UM	20	3	
 15.000	 15.000	204 20 HP	214 20 HP	224 20 HP	234 20 HP	20	3	
		204 20 HPB	214 20 HPB	224 20 HPB	234 20 HPB			
		204 20 HRC	214 20 HRC	224 20 HRC	234 20 HRC			
 20.000	 20.000	202 6 HP	212 6 HP	222 6 HP	232 6 HP	6	16	
		202 6 HPB	212 6 HPB	222 6 HPB	232 6 HPB			
		202 6 HRC	212 6 HRC	222 6 HRC	232 6 HRC			
 15.000	 15.000	202 8 HP	212 8 HP	222 8 HP	232 8 HP	8	16	
		202 8 HPB	212 8 HPB	222 8 HPB	232 8 HPB			
		202 8 HRC	212 8 HRC	222 8 HRC	232 8 HRC			





1:1



Form shape	Körnung grit	80	180	240	400	Ø mm	H mm
 5.000		202 12 HRB	212 12 HRB	222 12 HRB	232 12 HRB	12	18
		202 12 HRC	212 12 HRC	222 12 HRC	232 12 HRC		
 20.000		200 6 HP	210 6 HP	220 6 HP	230 6 HP	6	16
		200 6 HRB	210 6 HRB	220 6 HRB	230 6 HRB		
		200 6 HRC	210 6 HRC	220 6 HRC	230 6 HRC		
 15.000		205 17 HP	215 17 HP	225 17 HP	235 17 HP	17	2,5
		205 17 HRB	215 17 HRB	225 17 HRB	235 17 HRB		
		205 17 HRC	215 17 HRC	225 17 HRC	235 17 HRC		
 12.000		206 8 HP	216 8 HP	226 8 HP	236 8 HP	8 B=6	16
		206 8 HRB	216 8 HRB	226 8 HRB	236 8 HRB		
		206 8 HRC	216 8 HRC	226 8 HRC	236 8 HRC		
 5.000		203 12 HRB	213 12 HRB	223 12 HRB	233 12 HRB	12	20
		203 12 HRC	213 12 HRC	223 12 HRC	233 12 HRC		





**Minibestbürsten**  
**Minibest Brushes**  
**Brosses Minibest**  
**Cepillos Minibest**  
**Spazzole Minibest**

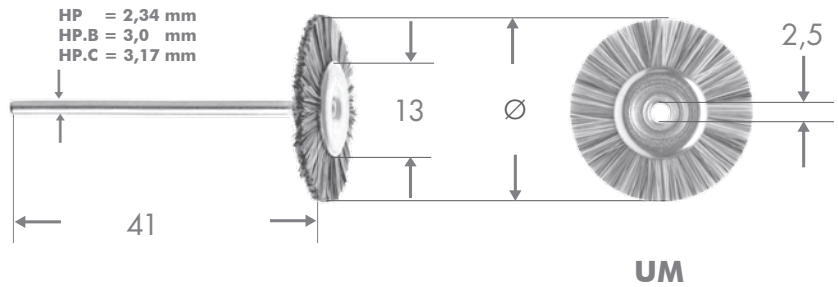

Besatzmaterial  
 filling material  
 matériel de garniture  
 guarnición  
 materiale utilizzato

10.000



	Ø	HP	HP.B	HP.C		UM
<b>weißes Ziegenhaar · white goat hair · poils de chèvre blancs · pelo de cabra blanco · pelo di capra bianco</b>						
	23	100 23 HP	100 23 HP.B	100 23 HP.C		100 23 UM
	25	100 25 HP	100 25 HP.B	100 25 HP.C		100 25 UM
	28	100 28 HP	100 28 HP.B	100 28 HP.C		100 28 UM
	32	100 32 HP	100 32 HP.B	100 32 HP.C		100 32 UM
<b>graues Ziegenhaar · grey goat hair · poils de chèvre gris · pelo de cabra gris · pelo di capra grigio</b>						
	23	102 23 HP	102 23 HP.B	102 23 HP.C		102 23 UM
	25	102 25 HP	102 25 HP.B	102 25 HP.C		102 25 UM
	28	102 28 HP	102 28 HP.B	102 28 HP.C		102 28 UM
	32	102 32 HP	102 32 HP.B	102 32 HP.C		102 32 UM
<b>graues Pferdehaar weich · grey horse hair soft · crins de cheval gris doux · crin de caballo gris blando · crine di cavallo grigio morbido</b>						
	23	112 23 HP	112 23 HP.B	112 23 HP.C		112 23 UM
	25	112 25 HP	112 25 HP.B	112 25 HP.C		112 25 UM
	28	112 28 HP	112 28 HP.B	112 28 HP.C		112 28 UM
	32	112 32 HP	112 32 HP.B	112 32 HP.C		112 32 UM
<b>silbergraues Pferdehaar standart hart · silvergrey horse hair standart hard · crins de cheval gris argent standart dur</b>						
	23	115 23 HP	115 23 HP.B	115 23 HP.C		115 23 UM
	25	115 25 HP	115 25 HP.B	115 25 HP.C		115 25 UM
	28	115 28 HP	115 28 HP.B	115 28 HP.C		115 28 UM
	32	115 32 HP	115 32 HP.B	115 32 HP.C		115 32 UM
<b>weiße Chungking Borsten · white chungking bristles · soie de Tchong King blanche · cerda de Chung King blanca · setola di Chungking bianca</b>						
	23	120 23 HP	120 23 HP.B	120 23 HP.C		120 23 UM
	25	120 25 HP	120 25 HP.B	120 25 HP.C		120 25 UM
	28	120 28 HP	120 28 HP.B	120 28 HP.C		120 28 UM
	32	120 32 HP	120 32 HP.B	120 32 HP.C		120 32 UM

Besatzmaterial  
filling material  
matériel de garniture  
guarnición  
materiale utilizzato

10.000

	Ø	HP	HP.B	HP.C		UM	
<b>schwarze Chungking Borsten</b> · black Chungking bristles · soie de Tchong King noire · cerda de Chung King negra · setola di Chungking nera							
	23	121 23 HP	121 23 HP.B	121 23 HP.C		121 23 UM	
	25	121 25 HP	121 25 HP.B	121 25 HP.C		121 25 UM	
	28	121 28 HP	121 28 HP.B	121 28 HP.C		121 28 UM	
	32	121 32 HP	121 32 HP.B	121 32 HP.C		121 32 UM	
<b>gewellter Messingdraht</b> · crimped brass wire · fil de laiton ondulé · alambre de latón ondulado · filo di ottone ondulado							
	Ø 0,10	23	143 23 HP	143 23 HP.B	143 23 HP.C		143 23 UM
		25	143 25 HP	143 25 HP.B	143 25 HP.C		143 25 UM
		28	143 28 HP	143 28 HP.B	143 28 HP.C		143 28 UM
		32	143 32 HP	143 32 HP.B	143 32 HP.C		143 32 UM
<b>gewellter Edeldraht</b> · crimped stainless steel wire · fil d'acier inoxydable ondulé · alambre de acero inoxidable ondulado · filo d'acciaio inossidabile ondulado							
	Ø 0,10	23	183 23 HP	183 23 HP.B	183 23 HP.C		183 23 UM
		25	183 25 HP	183 25 HP.B	183 25 HP.C		183 25 UM
		28	183 28 HP	183 28 HP.B	183 28 HP.C		183 28 UM
		32	183 32 HP	183 32 HP.B	183 32 HP.C		183 32 UM
<b>gewellter Stahldraht</b> · crimped steel wire · fil d'acier ondulé · alambre de acero ondulado · filo d'acciaio ondulado							
	Ø 0,10	23	193 23 HP	193 23 HP.B	193 23 HP.C		193 23 UM
		25	193 25 HP	193 25 HP.B	193 25 HP.C		193 25 UM
		28	193 28 HP	193 28 HP.B	193 28 HP.C		193 28 UM
		32	193 32 HP	193 32 HP.B	193 32 HP.C		193 32 UM
<b>Nylonfaser</b> · nylon fibre · fibres de nylon · fibra de nylon · fibra di nylon							
	Ø 0,30	23	286 23 HP	286 23 HP.B	286 23 HP.C		286 23 UM
		25	286 25 HP	286 25 HP.B	286 25 HP.C		286 25 UM
		28	286 28 HP	286 28 HP.B	286 28 HP.C		286 28 UM
		32	286 32 HP	286 32 HP.B	286 32 HP.C		286 32 UM
<b>HABRAS Bürsten AO 600</b> · HABRAS Brush AO 600 · Brosses HABRAS AO 600 · Cepillos HABRAS AO 600 · Spazzole HABRAS AO 600							
	Ø 0,30	23	400 23 HP	400 23 HP.B	400 23 HP.C		400 23 UM
		25	400 25 HP	400 25 HP.B	400 25 HP.C		400 25 UM
		28	400 28 HP	400 28 HP.B	400 28 HP.C		400 28 UM
		32	400 32 HP	400 32 HP.B	400 32 HP.C		400 32 UM





**Miniaturkelche, Miniaturpinsel (Endbürsten)**  
**Miniature Brushes cup shaped, End Brushes**  
**Brosses miniatures en forme de coupe, Mini pinceaux**  
**Cepillos miniaturas en forma de copa, pinceles**  
**Spazzole miniatura coppetta, pennelli**

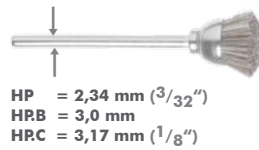
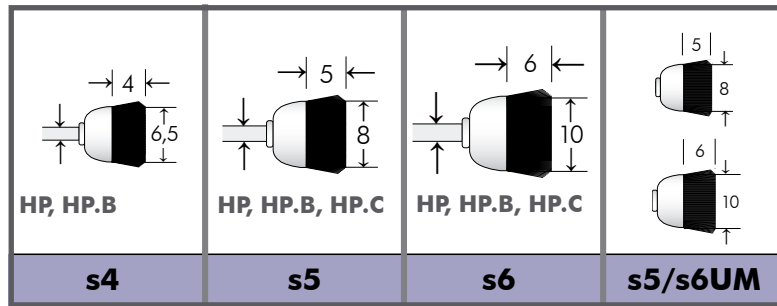

**montiert = Schaft**  
**mounted = shank**  
**tige**  
**vástago**  
**gambo**

**UM = unmontiert**  
**unmounted**  
**non montée**  
**no montado**  
**non montato**

**Besatzmaterial**  
**filling material**  
**matériel de garniture**  
**guarnición**  
**materiale utilizzato**

















10.000



	<b>s4</b>	<b>s5</b>	<b>s6</b>	<b>UM</b>
<b>weißes Ziegenhaar</b> white goat hair poils de chèvre blancs pelo de cabra blanco pelo di capra bianco	 100 s4 HP 100 s4 HP.B	 100 s5 HP 100 s5 HP.B 100 s5 HP.C	 100 s6 HP 100 s6 HP.B 100 s6 HP.C	 100 s5 UM 100 s6 UM
<b>graves Ziegenhaar</b> grey goat hair poils de chèvre gris pelo de cabra gris pelo di capra grigio		 102 s5 HP 102 s5 HP.B 102 s5 HP.C	 102 s6 HP 102 s6 HP.B 102 s6 HP.C	 102 s5 UM 102 s6 UM
<b>graves Pferdehaar</b> grey horse hair crins de cheval gris crin de caballo gris crine di cavallo grigio		 112 s5 HP 112 s5 HP.B 112 s5 HP.C	 112 s6 HP 112 s6 HP.B 112 s6 HP.C	 112 s5 UM 112 s6 UM
<b>silbergraves Pferdehaar hart</b> silvergrey horse hair hard crins de cheval gris argent dur crin de caballo gris argentado duro crine di cavallo grigio argen- tato duro		 115 s5 HP 115 s5 HP.B 115 s5 HP.C	 115 s6 HP 115 s6 HP.B 115 s6 HP.C	 115 s6 UM
<b>weiße Chungking Borsten</b> white Chungking bristles soie de Tchong King blanche cerda de Chung King blanca setola di Chungking bianca	 120 s4 HP 120 s4 HP.B	 120 s5 HP 120 s5 HP.B 120 s5 HP.C	 120 s6 HP 120 s6 HP.B 120 s6 HP.C	 120 s5 UM 120 s6 UM
<b>schwarze Chungking Borsten</b> black Chungking bristles soie de Tchong King noire cerda de Chung King negra setola di Chungking nera	 121 s4 HP 121 s4 HP.B	 121 s5 HP 121 s5 HP.B 121 s5 HP.C	 121 s6 HP 121 s6 HP.B 121 s6 HP.C	 121 s5 UM 121 s6 UM

Besatzmaterial  
filling material  
matériel de garniture  
guarnición  
materiale utilizzato

10.000

	s4	s5	s6	UM					
gewellter Messingdraht crimped brass wire fil de laiton ondulé alambre de latón ondulado filo di ottone ondolato									
					Ø 0,06 mm	141 s5 HP	141 s6 HP	141 s5 UM	
							141 s6 HP.B	141 s6 UM	
					Ø 0,08 mm	142 s4 HP	142 s5 HP	142 s6 HP	
						142 s4 HP.B	142 s5 HP.B	142 s6 HP.B	142 s5 UM
					Ø 0,10 mm			142 s6 HP.C	142 s6 UM
143 s4 HP	143 s5 HP	143 s6 HP							
143 s4 HP.B	143 s5 HP.B	143 s6 HP.B	143 s5 UM						
Ø 0,12 mm		143 s5 HP.C	143 s6 HP.C	143 s6 UM					
		144 s5 HP	144 s6 HP						
			144 s6 HP.B	144 s5 UM					
Ø 0,15 mm			144 s6 HP.C	144 s6 UM					
			145 s6 HP						
			145 s6 HP.B						
gewellter Edelstahlraht crimped stainless steel wire fil d'acier inoxydable ondulé alambre de acero inoxidable ondulado filo d'acciaio inossidabile ondolato									
					Ø 0,06 mm	181 s5 HP	181 s6 HP	181 s5 UM	
								181 s6 UM	
					Ø 0,08 mm		182 s5 HP	182 s6 HP	
								182 s6 HP.B	182 s5 UM
					Ø 0,10 mm			182 s6 HP.C	182 s6 UM
	183 s5 HP	183 s6 HP							
	183 s5 HP.B	183 s6 HP.B	183 s5 UM						
Ø 0,12 mm			183 s6 HP.C	183 s6 UM					
		184 s5 HP	184 s6 HP						
			184 s6 HP.B	184 s5 UM					
			184 s6 HP.C	184 s6 UM					
gewellter Stahldraht crimped steel wire fil d'acier ondulé alambre de acero ondulado filo d'acciaio ondolato									
					Ø 0,08 mm	192 s5 HP	192 s6 HP		
						192 s5 HP.B	192 s6 HP.B	192 s5 UM	
					Ø 0,10 mm			192 s6 HP.C	192 s6 UM
							193 s5 HP	193 s6 HP	
							193 s5 HP.B	193 s6 HP.B	193 s5 UM
Ø 0,12 mm			193 s6 HP.C	193 s6 UM					
		194 s5 HP	194 s6 HP						
			194 s6 HP.B	194 s5 UM					
Ø 0,15 mm			194 s6 HP.C	194 s6 UM					
			195 s6 HP						
Nylonfaser, transparent Nylon filament, transparent fibres de nylon, transparent fibra de nylon, trasparente fibra di nylon, trasparente									
					Ø 0,15 mm	282 s4 HP	282 s5 HP	282 s6 HP	
						282 s4 HP.B	282 s5 HP.B	282 s6 HP.B	282 s5 UM
					Ø 0,20 mm			282 s6 HP.C	282 s6 UM
								283 s6 HP	
								283 s6 HP.B	
Ø 0,30 mm			283 s6 HP.C	283 s6 UM					
			286 s6 HP	286 s6 UM					





**Miniaturlkelche, Miniaturpinsel (Endbürsten)**  
**Miniature Brushes cup shaped, End Brushes**  
**Brosses miniatures en forme de coupe, Mini pinceaux**  
**Cepillos miniaturas en forma de copa, pinceles**  
**Spazzole miniatura coppetta, pennelli**

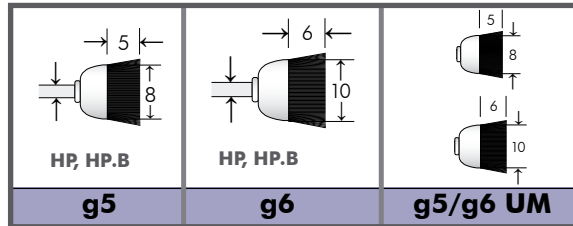

**g = gerade geschnitten**  
**straight cut**  
**coup droite**  
**corte recto**  
**taglio dell ritto**

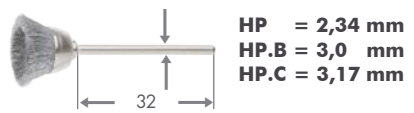

**Besatzmaterial**  
**filling material**  
**matériel de garniture**  
**guarnición**  
**materiale utilizzato**

5.000



	<b>g5</b>	<b>g6</b>	<b>UM</b>
weißes Ziegenhaar white goat hair poils de chèvre blancs pelo de cabra blanco pelo di capra bianco	 100 g5 HP 100 g5 HP.B	 100 g6 HP 100 g6 HP.B	
weiße Chungking Borsten white Chungking bristles soie de Tchong King blanche cerda de Chung King blanca setola di Chungking bianca	 120 g5 HP 120 g5 HP.B	 120 g6 HP 120 g6 HP.B	 120 g6 UM
schwarze Chungking Borsten black Chungking bristles soie de Tchong King noire cerda de Chung King negra setola di Chungking nera		 121 g6 HP 121 g6 HP.B	
gewellter Messingdraht crimped brass wire fil de laiton ondulé alambre de latón ondulado filo di ottone ondulado	 Ø 0,06 mm	 141 g6 HP	
	 Ø 0,08 mm	 142 g6 HP	
	 Ø 0,10 mm	 143 g6 HP 143 g6 HP.B	
	 Ø 0,12 mm	 144 g6 HP	
gewellter Edelstahlraht crimped stainless steel wire fil d'acier inoxydable ondulé alambre de acero inoxidable ondulado filo d'acciaio inossidabile ondulado	 Ø 0,08 mm	 182 g6 HP 183 g6 HP	
	 Ø 0,10 mm	 192 g6 HP 192 g6 HP.B 193 g6 HP	
gewellter Stahldraht crimped steel wire fil d'acier ondulé alambre de acero ondulado filo d'acciaio ondulado	 Ø 0,08 mm	 192 g6 HP 192 g6 HP.B 193 g6 HP	
	 Ø 0,10 mm	 192 g6 HP 192 g6 HP.B 193 g6 HP	
Nylonfaser, schwarz Nylon filament, black fibres de nylon, noir fibra de nylon, negra fibra di nylon, nero		 267 g6 HP	 267 g6 UM
Nylonfaser, transparent Nylon filament, transparent fibres de nylon, transparent fibra de nylon, trasparente fibra di nylon, trasparente	 Ø 0,15 mm	 282 g6 HP	 282 g6 UM
	 Ø 0,20 mm	 283 g6 HP	 283 g6 UM
	 Ø 0,30 mm	 286 g6 HP	

**Miniaturpinsel (Endbürsten)**  
**Miniature End Brushes**  
**Brosses miniature en forme de pinceau**  
**Cepillos en forma de pincel**  
**Spazzole a pennellino**



<b>p6 UM*</b>	<b>p6 UML*</b>	<b>p7</b>	<b>p8</b>	<b>p9</b>	<b>p10</b>	<b>p11</b>	<b>p12</b>	<b>p13</b>

5.000

**Besatzmaterial**  
 filling material  
 matériel de garniture  
 guarnición  
 materiale utilizzato

**\* nur zu verwenden mit SP 3 HP (Seite 66)**  
 use only with SP 3 HP  
 utiliser uniquement avec SP 3 HP  
 emplear solo con SP 3 HP  
 utilizzare solo con SP 3 HP



**weißes Ziegenhaar · white goat hair · poils de chèvre blancs · pelo de cabra blanco · pelo di capra bianco**

<b>100 p6 UM</b>	<b>100 p6 UML</b>	<b>100 p7 HP</b> <b>100 p7 HP.B</b> <b>100 p7 HP.C</b>	<b>100 p8 HP</b> <b>100 p8 HP.B</b> <b>100 e8 HP.C</b>	<b>100 p9 HP</b> <b>100 p9 HP.B</b> <b>100 p9 HP.C</b>	<b>100 p10 HP</b> <b>100 p10 HP.B</b> <b>100 p10 HP.C</b>	<b>100 p11 HP</b> <b>100 p11 HP.B</b> <b>100 p11 HP.C</b>	<b>100 p12 HP</b> <b>100 p12 HP.B</b> <b>100 p12 HP.C</b>	<b>100 p13 HP</b> <b>100 p13 HP.B</b> <b>100 p13 HP.C</b>

**weiße Chungking Borsten · white chungking bristles · soie de Tchong King blanche · cerda de Chung King blanca · setola di Chungking bianca**

<b>120 p6 UM</b>	<b>120 p6 UML</b>	<b>120 p7 HP</b> <b>120 p7 HP.B</b> <b>120 p7 HP.C</b>	<b>120 p8 HP</b> <b>120 p8 HP.B</b> <b>120 e8 HP.C</b>	<b>120 p9 HP</b> <b>120 p9 HP.B</b> <b>120 p9 HP.C</b>	<b>120 p10 HP</b> <b>120 p10 HP.B</b> <b>120 p10 HP.C</b>	<b>120 p11 HP</b> <b>120 p11 HP.B</b> <b>120 p11 HP.C</b>	<b>120 p12 HP</b> <b>120 p12 HP.B</b> <b>120 p12 HP.C</b>	<b>120 p13 HP</b> <b>120 p13 HP.B</b> <b>120 p13 HP.C</b>

**schwarze Chungking Borsten · black Chungking bristles · soie de Tchong King noire · cerda de Chung King negra · setola di Chungking nera**

<b>121 p6 UM</b>	<b>121 p6 UML</b>	<b>121 p7 HP</b> <b>121 p7 HP.B</b> <b>121 p7 HP.C</b>	<b>121 p8 HP</b> <b>121 p8 HP.B</b> <b>121 e8 HP.C</b>	<b>121 p9 HP</b> <b>121 p9 HP.B</b> <b>121 p9 HP.C</b>	<b>121 p10 HP</b> <b>121 p10 HP.B</b> <b>121 p10 HP.C</b>	<b>121 p11 HP</b> <b>121 p11 HP.B</b> <b>121 p11 HP.C</b>	<b>121 p12 HP</b> <b>121 p12 HP.B</b> <b>121 p12 HP.C</b>	<b>121 p13 HP</b> <b>121 p13 HP.B</b> <b>121 p13 HP.C</b>

**Nylonfaser transparent · nylon fibre, transparent · fibres de nylon, transparent · fibra de nylon, trasparente · fibra di nylon, trasparente**

<b>282 p6 UM</b>	<b>282 p6 UML</b>	<b>282 p7 HP</b> <b>282 p7 HP.B</b> <b>282 p7 HP.C</b>	<b>282 p8 HP</b> <b>282 p8 HP.B</b> <b>282 e8 HP.C</b>	<b>282 p9 HP</b> <b>282 p9 HP.B</b> <b>282 p9 HP.C</b>	<b>282 p10 HP</b> <b>282 p10 HP.B</b> <b>282 p10 HP.C</b>	<b>282 p11 HP</b> <b>282 p11 HP.B</b> <b>282 p11 HP.C</b>		



<b>p6 UM*</b>	<b>p6 UML*</b>	<b>p7</b>	<b>p8</b>	<b>p9</b>	<b>p10</b>	<b>p11</b>	<b>p12</b>	<b>p13</b>

Besatzmaterial  
filling material  
matériel de garniture  
guarnición  
materiale utilizzato

\* nur zu verwenden mit SP 3 HP (Seite 66)  
use only with SP 3 HP  
utiliser uniquement avec SP 3 HP  
emplear solo con SP 3 HP  
utilizzare solo con SP 3 HP

5.000



**gewellter Messingdraht** · crimped brass wire · fil de laiton ondulé · alambre de latón ondulado · filo di ottone ondulato

Ø 0,06 mm		141 p7 HP 141 p7 HP.B 141 p7 HP.C	141 p8 HP 141 p8 HP.B 141 e8 HP.C		141 p10 HP			
Ø 0,08 mm								
142 p6 UM	142 p6 UML	142 p7 HP 142 p7 HP.B 142 p7 HP.C	142 p8 HP 142 p8 HP.B 142 e8 HP.C			142 p11 HP 142 p11 HP.B 142 p11 HP.C		
Ø 0,10 mm								
143 p6 UM	143 p6 UML	143 p7 HP 143 p7 HP.B 143 p7 HP.C	143 p8 HP 143 p8 HP.B	143 p9 HP	143 p10 HP 143 p10 HP.B	143 p11 HP	143 p12 HP 143 p12 HP.B	143 p13 HP 143 p13 HP.B 143 p13 HP.C
Ø 0,12 mm								
		144 p7 HP 144 p7 HP.B 144 p7 HP.C	144 p8 HP 144 p8 HP.B 144 e8 HP.C		144 p10 HP 144 p10 HP.B 144 p10 HP.C	144 p11 HP 144 p11 HP.B 144 p11 HP.C		

**gewellter Edelstahlbraht** · crimped stainless steel wire · fil d'acier inoxydable ondulé · alambre de acero inoxidable ondulado · filo d'acciaio inossidabile ondulato

Ø 0,06 mm		181 p7 UM	181 p7 UML	181 p7 HP 181 p7 HP.B 181 p7 HP.C	181 p8 HP 181 p8 HP.B 181 e8 HP.C			
Ø 0,08 mm								
182 p6 UM	182 p6 UML	182 p7 HP 182 p7 HP.B 182 p7 HP.C	182 p8 HP 182 p8 HP.B 182 e8 HP.C			182 p11 HP 182 p11 HP.B 182 p11 HP.C		
Ø 0,10 mm								
183 p6 UM	183 p6 UML	183 p7 HP 183 p7 HP.B 183 p7 HP.C	183 p8 HP 183 p8 HP.B 183 e8 HP.C	183 p9 HP	183 p10 HP 183 p10 HP.B 183 p10 HP.C	183 p11 HP	183 p12 HP 183 p12 HP.B 183 p12 HP.C	183 p13 HP 183 p13 HP.B 183 p13 HP.C
Ø 0,12 mm								
		184 p7 HP 184 p7 HP.B 184 p7 HP.C	184 p8 HP 184 p8 HP.B 184 e8 HP.C		184 p10 HP 184 p10 HP.B 184 p10 HP.C	184 p11 HP 184 p11 HP.B 184 p11 HP.C		





<b>p6 UM*</b>	<b>p6 UML*</b>	<b>p7</b>	<b>p8</b>	<b>p9</b>	<b>p10</b>	<b>p11</b>	<b>p12</b>	<b>p13</b>

Besatzmaterial  
filling material  
matériel de garniture  
guarnición  
materiale utilizzato

\* nur zu verwenden mit SP 3 HP (Seite 66)  
Use only with SP 3 HP  
utiliser uniquement avec SP 3 HP  
emplear solo con SP 3 HP  
utilizzare solo con SP 3 HP

5.000



**gewellter Stahldraht** · crimped steel wire · fil d'acier ondulé · alambre de acero ondulado · filo d'acciaio ondulato

192 p6 UM	192 p6 UML	192 p7 HP 192 p7 HP.B 192 p7 HP.C	192 p8 HP 192 p8 HP.B 192 e8 HP.C			192 p11 HP 192 p11 HP.B 192 p11 HP.C		
<b>Ø 0,10 mm</b>								
193 p6 UM	193 p6 UML	193 p7 HP 193 p7 HP.B 193 p7 HP.C	193 p8 HP 193 p8 HP.B 193 e8 HP.C	193 p9 HP	193 p10 HP 193 p10 HP.B 193 p10 HP.C	193 p11 HP	193 p12 HP 193 p12 HP.B 193 p12 HP.C	193 p13 HP 193 p13 HP.B 193 p13 HP.C
<b>Ø 0,12 mm</b>								
	194 p6 UML	194 p7 HP 194 p7 HP.B 194 p7 HP.C	194 p8 HP 194 p8 HP.B 194 e8 HP.C	194 p9 HP	194 p10 HP 194 p10 HP.B 194 p10 HP.C	194 p11 HP 194 p11 HP.B 194 p11 HP.C		

**Baumwolle** · fine cotton thread · fil de coton fin  
hilo de algodón fino · filo di cotone fine



**Endbürsten mit Elastik Schutz** · end brushes with elastic protective cover · pinceaux avec protection de caoutchouc · pinceles con protección de goma · pennello con protezione elastica

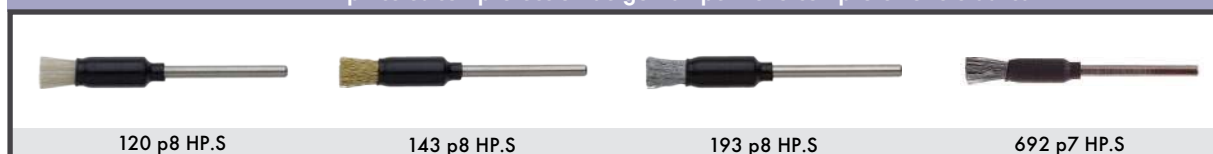



**Picobürsten**  
**Pico Brushes**  
**Brossettes Pico**  
**Cepillos Pico**  
**Spazzole Pico**

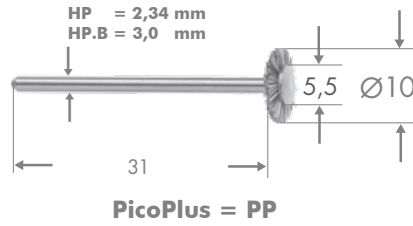

**Besatzmaterial**  
**filling material**  
**matériel de garniture**  
**guarnición**  
**materiale utilizzato**

	Ø 10 mm	PP
weißes Ziegenhaar white goat hair poils de chèvre blanc pelo de cabra blanca pelo di capra bianco ↳ 20.000		<b>100 10 PP</b> <b>100 10 PP.B</b>
graues Ziegenhaar grey goat hair poils de chèvre gris pelo de cabra gris pelo di capra grigio ↳ 20.000		<b>102 10 PP</b> <b>102 10 PP.B</b>
graues Pferdehaar grey horse hair crins de cheval gris crin de caballo gris crine di cavallo grigio ↳ 20.000		<b>112 10 PP</b> <b>112 10 PP.B</b>
silbergraues Pferdehaar silyergrey horse hair crins de cheval gris argent crin de caballo gris argentado crine di cavallo grigio argentato ↳ 20.000		<b>115 10 PP</b> <b>115 10 PP.B</b>
weiße Chungking Borsten white Chungking bristles soie de Tchong King blanche cerda de Chung King blanca setola di Chungking bianca ↳ 20.000		<b>120 10 PP</b> <b>120 10 PP.B</b>
schwarze Chungking Borsten black Chungking bristles soie de Tchong King noire cerda de Chung King negra setola di Chungking nera ↳ 20.000		<b>121 10 PP</b> <b>121 10 PP.B</b>
Baumwolle cotton thread fil de coton hilo de algodón filo di cotone ↳ 10.000		<b>150 10 PP</b> <b>150 10 PP.B</b>
gewellter Messingdraht Ø 0,08 mm crimped brass wire fil de laiton ondulé gambre de latón ondulado filo di ottone ondolato ↳ 10.000		<b>142 10 PP</b> <b>142 10 PP.B</b>
gewellter Edelstahlraht Ø 0,08 mm crimped stainless steel wire fil d'acier inoxydable ondulé gambre de acero inoxidable ondulado filo d'acciaio inossidabile ondolato ↳ 10.000		<b>182 10 PP</b> <b>182 10 PP.B</b>
gewellter Stahdraht Ø 0,08 mm crimped steel wire fil d'acier ondulé gambre de acero ondulado filo d'acciaio ondolato ↳ 10.000		<b>192 10 PP</b> <b>192 10 PP.B</b>
Scotch Brite™ grob Scotch Brite™ coarse Scotch Brite™ dur Scotch Brite™ grueso Scotch Brite™ grosso ↳ 10.000		<b>250 10 PP</b> <b>250 10 PP.B</b>



**Microbürsten**  
**Micro Brushes**  
**Brossettes Micro**  
**Cepillos Micro**  
**Spazzole Micro**

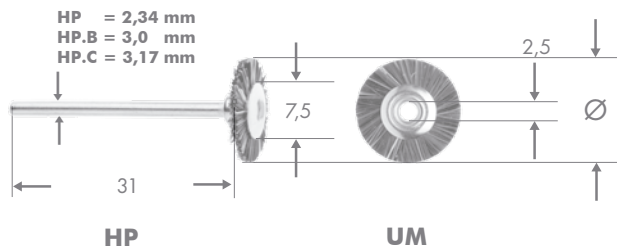

**Besatzmaterial**  
 filling material  
 matériel de garniture  
 guarnición  
 materiale utilizzato



	Ø 12 mm		Ø 14 mm	
weißes Ziegenhaar white goat hair poils de chèvre blanc pelo de cabra blanca pelo di capra bianco 15.000				
	<b>100 12 HP</b>	<b>100 12 UM</b>	<b>100 14 HP</b>	<b>100 14 UM</b>
graues Pferdehaar grey horse hair crins de cheval gris crin de caballo gris crine di cavallo grigio 15.000				
	<b>112 12 HP</b>	<b>112 12 UM</b>	<b>112 14 HP</b>	<b>112 14 UM</b>
silbergraues Pferdehaar silvergrey horse hair crins de cheval gris argent crin de caballo gris argentado crine di cavallo grigio argentato 15.000				
	<b>115 12 HP</b>	<b>115 12 UM</b>	<b>115 14 HP</b>	<b>115 14 UM</b>
weiße Chungking Borsten white Chungking bristles soie de Tchong King blanche cerda de Chung King blanca setola di Chungking bianca 15.000				
	<b>120 12 HP</b> <b>120 12 HRB</b>	<b>120 12 UM</b>	<b>120 14 HP</b> <b>120 14 HRB</b>	<b>120 14 UM</b>
schwarze Chungking Borsten black Chungking bristles soie de Tchong King noire cerda de Chung King negra setola di Chungking nera 15.000				
	<b>121 12 HP</b> <b>121 12 HRB</b>	<b>121 12 UM</b>	<b>121 14 HP</b> <b>121 14 HRB</b> <b>121 14 HRC</b>	<b>121 14 UM</b>
gewellter Messingdraht crimped brass wire fil de laiton ondulé alambre de latón ondulado filo di ottone ondulato 10.000				
Ø 0,06 mm	<b>141 12 HP</b> <b>141 12 HRB</b>	<b>141 12 UM</b>	<b>141 14 HP</b> <b>141 14 HRB</b>	<b>141 14 UM</b>
Ø 0,08 mm	<b>142 12 HP</b> <b>142 12 HRB</b> <b>142 12 HRC</b>	<b>142 12 UM</b>	<b>142 14 HP</b> <b>142 14 HRB</b> <b>142 14 HRC</b>	<b>142 14 UM</b>
Ø 0,10 mm	<b>143 12 HP</b>	<b>143 12 UM</b>	<b>143 14 HP</b>	<b>143 14 UM</b>
Ø 0,12 mm	<b>144 12 HP</b>	<b>144 12 UM</b>	<b>144 14 HP</b>	<b>144 14 UM</b>
Baumwolle grob coarse cotton thread fil de coton dur hilo de algodón grueso filo di cotone grosso 10.000				
	<b>150 12 HP</b>	<b>150 12 UM</b>	<b>150 14 HP</b> <b>150 14 HRB</b>	<b>150 14 UM</b>
Baumwolle fein fine cotton thread fil de coton fin hilo de algodón fino filo di cotone fine 10.000				
	<b>152 12 HP</b>	<b>152 12 UM</b>	<b>152 14 HP</b>	<b>152 14 UM</b>



**Microbürsten**  
**Micro Brushes**  
**Brossettes Micro**  
**Cepillos Micro**  
**Spazzole Micro**

**Besatzmaterial**  
 filling material  
 matériel de garniture  
 guarnición  
 materiale utilizzato



	Ø 12 mm		Ø 14 mm	
Nesseltuch muslin mousseline muselina tela in mussola				
	<b>160 12 HP</b>	<b>160 12 UM</b>	<b>160 14 HP</b> <b>160 14 HRB</b>	<b>160 14 UM</b>
↻ 15.000				
Flanell flannel flannelle franela flanella				
	<b>161 12 HP</b>	<b>161 12 UM</b>	<b>161 14 HP</b>	<b>161 14 UM</b>
↻ 15.000				
Filztuch felt cloth toile de feutre tela de fieltro feltro				
	<b>162 12 HP</b>	<b>162 12 UM</b>	<b>162 14 HP</b> <b>162 14 HRB</b>	<b>162 14 UM</b>
↻ 15.000				
gebleichter Nesselstoff bleached muslin cloth mousseline blanchie muselina blanqueada mussola tinta				
	<b>164 12 HP</b>	<b>164 12 UM</b>	<b>164 14 HP</b>	<b>164 14 UM</b>
↻ 15.000				
↻ 10.000 gewellter Edelstahldraht crimped stainless steel wire fil d'acier inoxydable ondulé alambre de acero inoxidable ondulado filo d'acciaio inossidabile ondulado				
	<b>181 12 HP</b> <b>181 12 HRB</b> <b>181 12 HRC</b>	<b>181 12 UM</b>	<b>181 14 HP</b> <b>181 14 HRB</b>	<b>181 14 UM</b>
↻ 10.000				
Ø 0,08 mm	<b>182 12 HP</b> <b>182 12 HRB</b>	<b>182 12 UM</b>	<b>182 14 HP</b> <b>182 14 HRB</b>	<b>182 14 UM</b>
Ø 0,10 mm	<b>183 12 HP</b> <b>183 12 HRB</b>	<b>183 12 UM</b>	<b>183 14 HP</b> <b>183 14 HRB</b>	<b>183 14 UM</b>
Ø 0,12 mm	<b>184 12 HP</b>	<b>184 12 UM</b>	<b>184 14 HP</b>	<b>184 14 UM</b>

**Microbürsten**  
**Micro Brushes**  
**Brossettes Micro**  
**Cepillos Micro**  
**Spazzole Micro**



**Besatzmaterial**  
 filling material  
 matériel de garniture  
 guarnición  
 materiale utilizzato



	Ø 12 mm		Ø 14 mm	
<p>gewellter Stahldraht                      crimped steel wire                      fil d'acier ondulé                      alambre de acero ondulado                      filo d'acciaio ondolato</p>				
<p>Ø 0,08 mm                      10.000</p>	<b>192 12 HP</b>	<b>192 12 UM</b>	<b>192 14 HP</b> <b>192 14 HRB</b>	<b>192 14 UM</b>
<p>Ø 0,10 mm</p>	<b>193 12 HP</b> <b>193 12 HRB</b>	<b>193 12 UM</b>	<b>193 14 HP</b>	<b>193 14 UM</b>
<p>Ø 0,12 mm</p>	<b>194 12 HP</b> <b>194 12 HRB</b>	<b>194 12 UM</b>	<b>194 14 HP</b>	<b>194 14 UM</b>
<p>Wildleder                      chamois leather                      peau de chamois                      cuero de gamuza                      pelle di camoscio</p>				
<p>10.000</p>	<b>500 12 HP</b>	<b>500 12 UM</b>	<b>500 14 HP</b>	<b>500 14 UM</b>
<p><b>COSIMA</b>                      Weiches silikoniertes                      Baumwollgewebe                      soft silicon coated cotton fabric                      tissu de coton doux et siliconé                      tejido blando de algodón                      siliconado                      tessuto di cotone siliconato                      morbido</p>				
	<b>869 12 HP</b>	<b>869 12 UM</b>	<b>869 14 HP</b>	<b>869 14 UM</b>
<p><b>COSIMA Soft</b>                      Silikoniertes Baumwollgewebe                      silicon coated cotton fabric                      tissu de coton siliconé                      tejido de algodón siliconado                      tessuto di cotone                      siliconato</p>				
	<b>870 12 HP</b>	<b>870 12 UM</b>	<b>870 14 HP</b>	<b>870 14 UM</b>
<p>Scotch Brite™ grob                      Scotch Brite™ coarse                      Scotch Brite™ dur                      Scotch Brite™ grueso                      Scotch Brite™ grosso</p>				
<p>5.000</p>			<b>250 14 HP</b>	<b>250 14 UM</b>



**Diamantierte Bürsten und Polierer, DiaDisc**  
**Diamond Brushes and Polishers, DiaDisc**  
**Brosses et polissoirs diamantés, DiaDisc**  
**Cepillos y pulidores diamantados, DiaDisc**  
**Spazzole diamantate e lucidanti, DiaDisc**



HP = 2,34 mm  
 HP.B = 3,0 mm  
 HP.C = 3,14 mm

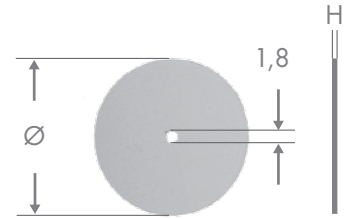
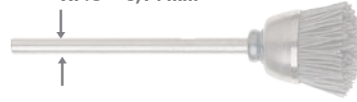





**NyDiFi Bürsten**  
**NyDiFi Brushes**  
**Brosses NyDiFi**  
**Cepillos NyDiFi**  
**Spazzole NyDiFi**

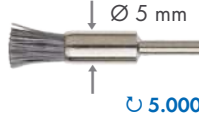

**Körnung**  
**grit**



**Code**

		Ø 22 mm	p8	s6
				
		∩ 10.000	∩ 5.000	∩ 10.000
Ø 0,40		<b>356 22 HP</b> <b>356 22 HP.B</b> <b>356 22 HP.C</b>	<b>356 p8 HP</b> <b>356 p8 HP.B</b> <b>356 e8 HP.C</b>	<b>356 s6 HP</b> <b>356 s6 HP.B</b> <b>356 s6 HP.C</b>
Ø 0,25		<b>358 22 HP</b> <b>358 22 HP.B</b> <b>358 22 HP.C</b>	<b>358 p8 HP</b> <b>358 p8 HP.B</b> <b>358 e8 HP.C</b>	<b>358 s6 HP</b> <b>358 s6 HP.B</b> <b>358 s6 HP.C</b>
Ø 0,25		<b>360 22 HP</b> <b>360 22 HP.B</b> <b>360 22 HP.C</b>	<b>360 p8 HP</b> <b>360 p8 HP.B</b> <b>360 e8 HP.C</b>	<b>360 s6 HP</b> <b>360 s6 HP.B</b> <b>360 s6 HP.C</b>



**Diamantpolierer**  
**diamond polishers**  
**polissoirs diamantés**  
**pulidores diamantados**  
**abrasivi diamantati**



	Ø 16 mm
∩ 10.000	<b>334 16 UM</b>
	Ø 4 mm
∩ 15.000	<b>333 4 HP</b>
	Ø 11 mm
∩ 10.000	<b>334 11 HP</b>

**DiaDisc**  
**DiaDisc**



∩ 5.000



Art.Nr. art.No.	Farbe Color	Korngröße grit size	Ø mm	H mm
343 22 R	Blau Blue Bleu Azul Blu	extra fein extra fine extra fin extra fino extra fine	22	0,5
346 22 R	Grün Green Vert Verde Verde	fein fine fin fino fine	22	0,5

DiaStone\_Z, DiaStone\_L  
DiaStone\_Z, DiaStone\_L

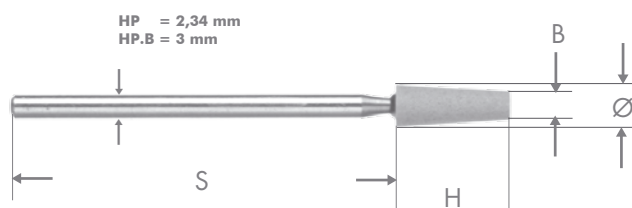

DiaStone



































	Art.Nr. art.No.	Farbe color	Anwendung application	Korngröße grit size	S mm	H mm	Ø mm	B mm
 10.000	327 4 HP	■ ■	L	extra fein, extra fine, extra fin, extra fino, extrafine 800	33	11	4	3
	367 4 HP	■	Z					2,5
	337 4 HP	■ ■	L	mittel, medium, medium, medio, media 200	33	11	4	3
	377 4 HP <sup>+</sup>	■	Z					2,5
	387 4 HP	■ ■	L	grob, coarse, dur, grueso, grossa 120	33	11	4	3
	397 4 HP <sup>+</sup>	■	Z					2,5
 10.000	322 4 HP	■ ■	L	extra fein, extra fine, extra fin, extra fino, extrafine 800	34	12	4	
	362 4 HP	■	Z					4,8
	332 4 HP	■ ■	L	mittel, medium, medium, medio, media 200	34	12	4	
	372 4 HP <sup>+</sup>	■	Z					4,8
	382 4 HP	■ ■	L	grob, coarse, dur, grueso, grossa 120	34	12	4	
	392 4 HP	■	Z					4,8
 10.000	332 6 HP	■ ■	L	mittel, medium, medium, medio, media 200	34	12	6	
	372 6 HP <sup>+</sup>	■	Z					6,5
	382 6 HP	■ ■	L	grob, coarse, dur, grueso, grossa 120	34	12	6	
	392 6 HP <sup>+</sup>	■	Z					6,5
 10.000	371 5 HP	■	Z	mittel, medium, medium, medio, media 200	33		5	
 10.000	334 15 HP	■ ■	L	mittel, medium, medium, medio, media 200	40		15	3
	374 15 HP <sup>+</sup>	■	Z					3,5
	334 15 R	■ ■	L					3
	374 15 R	■	Z					3,5
 10.000	335 22 HP	■ ■	L	mittel, medium, medium, medio, media 200	40		22	3
	375 22 HP	■	Z					2,2
	335 22 R	■ ■	L					3
	375 22 R	■	Z					2,2

- + HP.B lieferbar
- + HP.B deliverable
- + disponible avec tige HP.B
- + disponible con vástago de HP.B
- + disponibile con gambo di HP.B

**Z** empfohlen für ZrO<sub>2</sub>-Keramik  
recommended for ZrO<sub>2</sub> Ceramic  
recommandé pour ZrO<sub>2</sub> céramique  
recomendado para ZrO<sub>2</sub> cerámica  
raccomandato per ZrO<sub>2</sub> ceramica

**L** empfohlen für LiSi<sub>2</sub>, Hybridkeramik  
recommended for LiSi<sub>2</sub>, Hybrid ceramics  
recommandé pour LiSi<sub>2</sub> céramiques hybrides  
recomendado para LiSi<sub>2</sub> cerámica híbrida  
raccomandato per LiSi<sub>2</sub> ceramica ibrida

Anwendung  
 Application • Application  
 Aplicación • Applicazione

Vorpolitur • pre-polishing • pré polissage • prepulido • prelucidatura								
Braun Brown Marron Marrón Marron		110g Ref.No. 313176		370g Ref.No. 313177		1,7 kg Ref.No. 313130	CuSn CuZn Au 333 Au 583	
Lintygrau Lintygrey Lintygris Lintygris Lyntygrigio		90g Ref.No. 313168		280g Ref.No. 313175		1,2 kg Ref.No. 313150	Ag 925 Au 750 Au 916 3D PMMA	
Glanzpolitur • shine polishing • poli brillant • pulido • lucidatura								
Creme Cream Creme Crema Crema		90g Ref.No. 313200					Al CuZn CuSn 3D PMMA Ag 925 Au 333	
Weiß White Blanc Blanco Bianco		90g Ref.No. 313162		290g Ref.No. 313169		1,4 kg Ref.No. 313131	CrNi CuZn CuSn Au 333 Au 583	
Hochglanzpolitur • high shine polishing • Lustrage • abrillantado • brillantatura								
Grün Green Vert Verde Verda		90g Ref.No. 313166		300g Ref.No. 313173		1,4 kg Ref.No. 313132	CrNi CuZn CuSn Au 333 Au 583	
Rot Red Rouge Rojo Rosso		100g Ref.No. 313163		300g Ref.No. 313170		1,1 kg Ref.No. 313114	Ag 925 Au 750 Au 916	
Blau Blue Bleu Azul Blu		75g Ref.No. 313165		290g Ref.No. 313172		1,1 kg Ref.No. 313133	Ag 925 Au 750 Au 916 Pt 950	
Rosa Pink Rose Rosa Rose		75g Ref.No. 313164		290g Ref.No. 313171		1,1 kg Ref.No. 313153	Au 916 Pt 950	
Beige Beige Beige Beige Beige		85g Ref.No. 313167		290g Ref.No. 313174		1,2 kg Ref.No. 313134		





**Polistar Polierpasten**  
**Polistar Polishing Compounds**  
**Pâtes à polir Polistar**  
**Pastas de pulido Polistar**  
**Paste per lucidare Polistar**



Anwendung  
 Application • Application  
 Aplicación • Applicazione

Spiegelglanz • mirror finish • fini miroir • brillo especular • lucidatura a specchio				
<b>Pro Rosa</b> Pro Pink Pro Rose Pro Rosa Pro Rose		150g  Ref.No. 313196	Al CuZn CuSn Au 333 3D PMMA	
<b>Pro Orange</b> Pro Orange Pro Orange Pro Naranja Pro Arancio		150g  Ref.No. 313188	Au 583 Au 750 Au 916	
<b>Pro Blau</b> Pro Blue Pro Bleu Pro Azul Pro Blu		150g  Ref.No. 313197	CrNi Ag 925 Pt 950	

Spiegelglanz • mirror finish • fini miroir • brillo especular • lucidatura a specchio				
<b>Diamant</b> Diamond Diamant Diamante Diamante	3µm  1,5g Ref.No. 313085	3µm  4g Ref.No. 313081	Pro Diamant 2µm  12g Ref.No. 313214	CrNi Pt 950 ZrO <sub>2</sub>

Finale Politur • final polishing • pollissage finale • polido finale • pulido finale				
<b>Emulsion</b> Emulsion Emulsion Emulsión Emulsione	 50 ml  Ref.No. 313148	 125 ml  Ref.No. 313139	Al CuZn CuSn Ag 925 Au 333 Au 583 Au 750 Au 916 Pt 950	

**Dental Dental Dentaire Dental Dentale**

Kunststoff acrylic résine resines resina	Thermoplast thermoplastic thermoplastique thermoplastico	Komposit composite composite composito	Modellguss frame work armature armadura Scheletrati	Edelmetall precieux précieux preziosi	NEM non-precious non-précieux non-preziosi	Keramik ceramic céramique ceramico	Titan titanium titane titano	Zirkon/LiSi <sub>2</sub> zirconium zircon zircón zircono

**Polistar-Muster-Kit  
 Polistar-Sample-Kit**



**Schmuck Jewellery Bijouterie Joyas Gioielleria**

<b>CrNi</b>	<b>Al</b>	<b>CuZn CuSn</b>	<b>Ag 925</b>	<b>Au 333</b>	<b>Au 583</b>	<b>Au 750</b>	<b>Au 916</b>	<b>Pt 950</b>	<b>ZrO<sub>2</sub></b>	<b>3D PMMA</b>
Edelstahl Stainless inox inoxidable inox	Aluminium aluminum aluminium aluminio	Kupfer/Bronze copper/brass cuivre/laiton cobre/bronce rame/bronzo	Silber silver argent plata argento	8 Kt	14 Kt	18 Kt	22 Kt	Platino platinum platine platino platino	Zirkon zirconium zircon zircón zircono	Kunststoff acrylic résine resines resina

Ref.No.  
314315



**Mandrels, Werkzeugständer, Fingerlinge, Polierzopf**  
**Mandrels, Instrument Holder, Finger Stalls, Polishing Tress**  
**Mandrins, présentoir vide, doigts, tresse à polir**  
**Mandriles, expositores, dediles, trenzado de pulido**  
**Mandrini, Portastrumenti, ditali in pelle, fili per lucidare in treccia**

Schraubmandrell mit Gewinde  
 Screwmandrels with fits hole  
 Mandrin porte-meulette  
 Mandriles de tornillo con rosca  
 Mandrini con filetto



Spannmandrell mit Gewinde  
 Pinmandrels with fits hole  
 Mandrin porte-cylindre  
 Mandriles de aprisionamiento con rosca  
 Mandrini a serraggio

Ø 1,7 mm 1/16"				Ø 2,5 mm 1/10"	Ø 3,0 mm 1/8"	
<b>SM 5 HP</b>	<b>SM 5 HRB</b>	<b>SV 5 HP</b>	<b>SM 8 HP</b>	<b>SM MiMa 8 HP</b>	<b>SMC 5 HP</b>	<b>SMC 5 HP.C</b>
<b>313031</b>	<b>313032</b>	<b>313070</b>	<b>313182</b>	<b>313082</b>	<b>313115</b>	<b>313119</b>

Ø 3,0 mm 1/8"
<b>SP 3 HP*</b>
<b>313030</b>

\* siehe Seite 55-57  
 see page 55-57  
 voir page 55-57  
 ver page 55-57  
 vedere page 55-57

Werkzeugständer leer  
 Empty instrument holder  
 Présentoir vide  
 Expositor vacío  
 Portastrumento vuoto

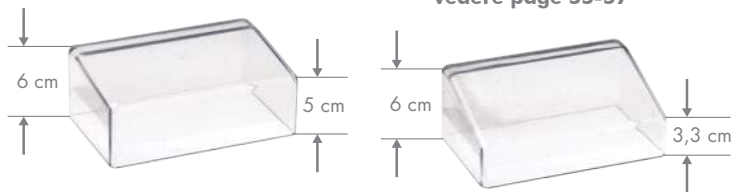

Ref.No.

**313048**

**313045**

**313057**

**313056**

Schutzkappe mit Partikelfänger  
 Protector and particle collector  
 Collecteur de poussière  
 Colector de polvo  
 Collettore di polveri



Ref.No.

**314386**

Fingerlinge aus Leder  
 Leather finger stalls  
 Doigtiers en cuir  
 Dediles de cuero  
 Ditali in pelle

Art.No.	Größe sizes	
<b>PF 1</b>	Kleiner Finger little finger petit dedo meñique Mignolo	<b>1</b>
<b>PF 2</b>	Ringfinger ring finger annulaire dedo anular Anulare	<b>2</b>
<b>PF 3</b>	Zeigefinger index finger index dedo indice Indice	<b>3</b>
<b>PF 4</b>	Daumen thumb pouce Dedo pulgar Pollice	<b>4</b>



Polierfäden als Zopf  
 Polishing threads as tress  
 Ficelle à polir comme tresse  
 El trenzado de hilos de pulido  
 Fili per lucidare sotto forma di treccia



**157 250 PF**

Ref.No.

**314127**

Feines Baumwollgarn, 250 Fäden  
 Fine cotton yarn, 250 threads  
 Fil de coton fin, 250 fils  
 Hilo de algodón fino, 250 piezas  
 Filo di cotone fino, 250 fili

**Mattierstylos und Instrumentenreiniger**  
**Scratch Brush Pens and Bur Cleaner**  
**Stylos à nettoyer les outils**  
**Lápiz para mateado y cepillo de limpiar en acero**  
**Matita per satinare e matita con punta in acciaio**



**Art.Nr.**  
**art.No.**

**630 00** Mattierstylo mit Glasfasereinsatz · Glass fiber matting handle  
 Stylo en fibre de verre · Lápiz para mateado con recambio de fibras de vidrio  
 Matita per satinare con punta in fibra di vetro



**630 01** Glasfasereinsatz · Glass fiber refill · Recharge fibre de verre  
 Recambio de fibras de vidrio · Ricambi in fibra di vetro



**642 00** Stahlbohrereiniger mit glattem Messingdraht · Steel bur cleaner with straight brass wire  
 Stylo en fil de laiton · Rascador para fresas de acero con alambre de latón liso  
 Matita per pulire le frese in acciaio con punta in filo d'ottone liscio



**642 01** Messingdrahteinsatz · Brass wire refill  
 Recharge fil de laiton · Recambio de alambre de latón  
 Ricambi in filo d'ottone liscio



**682 00** Diamantschleiferreiniger mit glattem Edelstahlraht · Diamond bur cleaner with straight stainless steel wire  
 Stylo en fil d'acier inoxydable lisse pour nettoyer les outils · Rascador para muelas diamantadas con alambre de acero inoxidable liso · Matita per pulire le frese diamantate con punta in filo d'acciaio inossidabile liscio



**682 01** Edelstahlrahteinsatz · Stainless steel refill straight  
 Recharge acier inoxydable lisse · Recambio de alambre de acero inoxidable liso  
 Ricambi in filo d'acciaio liscio inossidabile liscio



**692 00** HM-Bohrereiniger mit glattem Stahl · Carbide bur cleaner with straight steel wire  
 Stylo en fil d'acier pour nettoyer les forets · Rascador para fresas de carburo con alambre de acero liso · Matita per pulire le frese in carburo di tungsteno con punta in filo d'acciaio liscio



**692 01** Stahlrahteinsatz · Steel wire refill  
 Recharge fil d'acier · Recambio de alambre de acero  
 Ricambi in filo d'acciaio liscio

**143 60 NI**

Reinigungsbürste mit Schieblasche, gewellter Messingdraht  
 Scrubbing brush with grafter, crimped brass wire  
 Grattoir à fraise en fil de laiton ondulé  
 Cepillo de limpieza con oreja deslizante, alambre de latón ondulado  
 Nettafresa con barretta scorrevole in filo d'ottone ondulado

**143 KB 30**

Kratzbürste starr, gewellter Messingdraht  
 Scrubbing brush with grafter, crimped brass wire  
 Grattoir à fraise en fil de laiton ondulé  
 Cepillo rascador rígido, alambre de latón ondulado  
 Nettafresa rigido in filo d'ottone ondulado

**294 55/20 Ni**

Instrumentenreiniger für die Fußpflege, Nylon  
 Instrument cleaner for foot care / podiatry Nylon  
 Brosse en acier en pédicure, nylon

**294 55/25 Ni**

Cepillo de limpiar en acero para la pedicura, nylon  
 Spazzolino per pulire gli strumenti per pedicura in nylon

# FiberDisc

Faserverstärkte Trennscheiben  
 Reinforced Fiber Discs  
 Disques à tronçonner renforcés de fibres  
 Muela de tronzar reforzado con fibras  
 Dischi di separazione in fibra rinforzata



**Info**



- Ø 40 mm = 5.000 rpm
- Ø 25 mm = 10.000 rpm
- Ø 22 mm = 15.000 rpm
- Ø 20 mm = 15.000 rpm

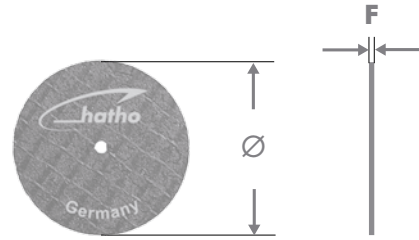

**Für Metall mit Aluminium Oxide**  
 For metal with aluminum oxide  
 Pour les alliages avec oxyde aluminium  
 Para metal con óxidos de aluminio  
 Per metallo con ossido di alluminio



Art.Nr. art.No.	Ø mm	F mm
654 22x02 H	22	0,2
654 22x03 H	22	0,3
654 22x05 H	22	0,5
654 25x02 H	25	0,2
654 25x03 H	25	0,3
654 25x05 H	25	0,5
654 40x05 H	40	0,5
654 40x07 H	40	0,7
654 40x10 H	40	1,0

10

**Für Keramik mit Siliziumkarbid**  
 For ceramic with silicon carbide  
 Pour la céramique avec carbure de silice  
 Para cerámica con carburo de silicio  
 Per ceramica con carburo di silicio

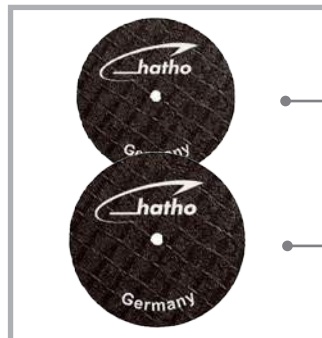

754 22x02 H	22	0,2
754 22x03 H	22	0,3
754 25x02 H	25	0,2
754 25x03 H	25	0,3

10

**Für Keramik und Zirkon mit Diamant**  
 For ceramic and zirconium with diamond  
 Pour la céramique et le zircon avec du diamant  
 Para cerámica y circon con diamante  
 Per ceramica e zircone con diamante



854 20x02 H	20	0,2
854 20x03 H	20	0,3

1

**Naturhaarpinsel**  
**Natural Hair Brush**  
**Pinceau en soies naturelles**  
**Cepillos de pelos naturales**  
**Pennelli in setole naturali**



1:1	Bezeichnung description	Art.Nr. art. No.	Größe size	Charakter character
	Tamara-Mustela 00	TK 00	00	<p>Feinstes Wieselhaar, bauchiges Haarbündel, feine stabile Pinselspitze, dreieckiger Handgriff.            Finest Weasel hair, belly hair bundle, thin stable tip, triangular handle.            Poils fins de martre, forme ventrue, pointe fine et stable, poignée triangulaire.            Pelo de marta finísimo, mechón abombado, punta fina y firme, mango triangular            Setola di martora di qualità superiore, forma della punta del pennello arrotondata, sottile e stabile, manico triangolare</p>
	Tamara-Mustela 0	TK 0	0	
	Tamara-Mustela 2	TK 2	2	
	Tamara-Mustela 4	TK 4	4	
	Tamara-Mustela 6	TK 6	6	
	Tamara-Mustela 8	TK 8	8	
	Murena-Zobel 00	MZ 00	00	<p>Feinstes Zobelhaar, kegeliges Haarbündel, flexible Pinselspitze, runder Handgriff.            Finest sable hair, beveled hair bundle, thin flexible tip, round handle            Poils fins de Zibeline, forme de torpédo, pointe flexible, poignée arrondie.            Pelo sabeline finísimo, mechón cónico, punta blanda, mango redondo            Setola di zibellino di qualità superiore, forma della punta del pennello affusolata, sottile e flessibile, manico rotondo.</p>
	Murena-Zobel 0	MZ 0	0	
	Murena-Zobel 2	MZ 2	2	
	Murena-Zobel 4	MZ 4	4	
	Murena-Zobel 6	MZ 6	6	
	Murena-Zobel 8	MZ 8	8	
	Samyra-Zobel 0	SP 0	0	<p>Feinstes Zobelhaar, flaches Haarbündel, runder Handgriff            Finest sable hair, flat hair bundle, round handle            Poils fins de Zibeline, plat, poignée arrondie            Pelo sabeline finísimo, mechón plateado, mango redondo            Setola di zibellino di qualità superiore, forma piatta della punta del pennello, manico rotondo</p>
	Samyra-Zobel 02	SP 02	02	



**Spindeladapter, Musterkollektionen**  
**Bur Chucks, Sample Collections**  
**Porte-brossette, collection d'échantillons**  
**Porta cepillos, colecciones de muestras**  
**Adattatore per mandrini, Campionario di spazzole**



Adapter zur Montage von Schaftbürsten auf Poliermotor  
 Adapter for mounting shank brushes on conical spindle of a polishing unit  
 Porte-brossette pour le montage de brosses sur tige sur les tour a polir  
 Un adaptador para el montaje de los cepillos en las maquinas de pulimento  
 Adattatore per utilizzare spazzolini montati sulla lucidatrice

**ALUCOLOR** Spindeladapter · bur chuck · Porte-brossette  
 Porta cepillos · Adattatore per mandrini

						 Ø 2,34 mm <b>314 254</b>
<b>AS 400</b> <b>314244</b>	<b>AS 450</b> <b>314245</b>	<b>AS 500</b> <b>314246</b>	<b>AS 550</b> <b>314247</b>	<b>AS 600</b> <b>314248</b>	<b>AS 700</b> <b>314250</b>	

Spannzangen  
 collets  
 pinces  
 pinzas  
 morsettos  
 Ref.No.

**FILIO®**  
 Spindeladapter aus Edelstahl · bur chuck from stainless steel · Porte-brossette inoxidable  
 porta cepillo de acero inoxidable · Adattatore per mandrini in acciaio inossidabile

<b>FILIO Typ A</b> <b>314251</b>	<b>FILIO Typ B</b> <b>314252</b>	<b>FILIO Typ C</b> <b>314253</b>

Ref.No.

Musterkollektion Miniatur- und Rundbürsten  
 Sample collection miniature- and lathe brushes  
 Collection d'échantillons brosses miniatures et brosses circulaires  
 Colección de muestras con cepillos miniatur y cepillos para el pulido  
 Campionario di spazzole „Miniatur“e dischi



Ref.No.  
**314184**

Musterkollektion HABRAS Discs  
 Sample collection HABRAS Discs  
 Collection d'échantillons HABRAS Disc  
 Colección de muestras con HABRAS Disc  
 Campionario di spazzole „HABRAS Discs,“



Ref.No.  
**314243**

**Mattschlagbürsten**  
**Matting Brushes**  
**Brosses à mater**  
**Cepillos para matar**  
**Spazzole per satinare**



### MaxiMat PRO

max 2.800 rpm

			
Ø 0,20 mm	Ø 0,30 mm	Ø 0,45 mm	Ø 0,60 mm
Ref.No. 314233	Ref.No. 314234	Ref.No. 314235	Ref.No. 314236





Oberflächenstrukturen · Surface structures · Les structures de surface · Estructura superficial · Struttura delle superfici

### MaxiMat PRO Federn, abgewinkelt · wires, angled · fils pliés · fillos angulados · fili piegati

			
Ø 0,20 mm	Ø 0,30 mm	Ø 0,45 mm	Ø 0,60 mm
Ref.No. 314229	Ref.No. 314230	Ref.No. 314231	Ref.No. 314232

### MiniMat

max 8.000 rpm

		
Ø 0,30 mm	Ø 0,45 mm	Ø 0,60 mm
Ref.No. 314193	Ref.No. 314194	Ref.No. 314195

### MiniMat Federn · threads · files · fillos · fili mini

		
Ø 0,30 mm	Ø 0,45 mm	Ø 0,60 mm
Ref.No. 314207	Ref.No. 314208	Ref.No. 314209



MiniMat Set

Ref.No.  
314196



MiniMat Mandrel  
 MiniMat mandrel  
 MiniMat mandrin  
 MiniMat mandril  
 MiniMat Mandrino

Ref.No.  
313082

MiniMat Arbeitsteil  
 MiniMat core  
 MiniMat partie travaillante  
 MiniMat mandril especial  
 MiniMat centro ricaricabile



Ref.No.  
314203

## Politur Sortimente

### Polishing Kits · Assortiment de polissage

### Juegos para pulido · Set per lucidare

#### AcryPol Set ID Nr. 313120



Politur Sortiment mit Ideal-Einlagebürsten, Mikrofaser-Lederschwabbel, feine Baumwollmulle und die Polierpaste Polistar Beige für die rationelle Hochglanzpolitur von Dentalkunststoffen aus Methylmethacrylaten.  
 Polishing assortment including Ideal-Multi-Layer brushes, Microfiber-Leather polishing buff, fine cotton buff and a bar of Polishing Beige compound for high shine polishing of dental acrylics  
 Assortiment de polissage avec des brosse disques intercalés Idéal, une disque en cuir microfibre, une brosse en coton et une pâte beige Polistar pour le lustrage des résines dentaires en Methylmetacrylate.  
 Surtido de pulido con cepillos multicapas Ideal, disco de cuero de microfibra, gasa de algodón fina y pasta Polistar Beige para el abrillantado económico de plásticos dentales de metacrilatos metílicos  
 Assortimento per lucidare contenente dischi multistrato "Ideal", disco in ecopelle microfibra, moscione con fili di cotone fini e pasta per lucidare Polistar beige in barretta per una lucidatura a specchio di resine dentali

Inhalt, contents, contenu, contenido, contenuto:  
 2x 9280 / 1x 520 100/7 / 1x 156 80 HS / 1x Polistar Beige 100 g

#### DistoPol Set ID Nr. 313086



Politur Sortiment mit Diamantpaste und kleinen Filzkörpern für die rationelle Hochglanzpolitur von Metalllegierungen (edel und unedel), Keramiken, Kompositen, Titan  
 Polishing assortment including diamond paste and miniature felt polishers for high shine polishing of all metals (precious and non-precious), ceramics, composites and titanium  
 Assortiment avec une pâte diamantée et des petits feutres pour le lustrage de tous les alliages des métaux (précieux et non-précieux), céramiques, composites et titane  
 Surtido de pulido con pasta de diamante y pequeñas muelas de fieltro para abrillantado económico de alcaciones metálicas (preciosas y no preciosas), céramicas, composites y titanio  
 Assortimento per lucidare contenente pasta diamantata e piccoli feltrini, per una lucidatura a specchio di tutte le leghe metalliche (nobili e vili), ceramica, compositi e titanio.

Inhalt, contents, contenu, contenido, contenuto:  
 1x Polistar Diamant 1,5 g / 6x 174 12x3 / 6x 175 12 UM / 1x SM 5 HP

#### CeroPol Set ID Nr. 313087



Politur Sortiment mit Diamantpaste und Kombibürsten für die rationelle Hochglanzpolitur von Metalllegierungen (edel und unedel), Keramiken, Kompositen, Titan  
 Polishing assortment including diamond paste and Kombi brushes for high shine polishing of all metals (precious and non-precious), ceramics, composites and titanium  
 Assortiment de polissage avec une pâte diamantée et une combinaison de brochettes pour le lustrage de tous les alliages de métaux (précieux et non-précieux), céramiques, composites et titane.  
 Surtido de pulido con pasta de diamante y cepillos Kombi para el abrillantado económico de alcaciones metálicas (preciosas y no preciosas), céramicas, composites y titanio  
 Assortimento per lucidare contenente pasta diamantata e spazzolini "Kombi", per una lucidatura a specchio di leghe metalliche (nobili e vili), ceramica, compositi e titanio

Inhalt, contents, contenu, contenido, contenuto:  
 1x Polistar Diamant 2,5 g / 3x 100/500 22 HP / 3x 102/500 22 HP

#### Polistar Koffer ID Nr. 313140



Politur Sortiment mit ZETA Tuschschwabbel, schmale Baumwollmulle und die Polierpaste Polistar Lintygrau zur Vorpolitur sowie eine Flasche Emulsion für die Abschlusspolitur von Dentalkunststoffen aus Methylmethacrylaten  
 Polishing assortment including ZETA cloth buff, small cotton buff, a bar of Polishing Lintygrey compound for the pre-polishing and Polistar Emulsion for the final gloss polishing of dental acrylics  
 Assortiment de polissage avec un disque en toile ZETA, une brosse en coton étroite et la pâte à polir, Polistar linygris pour le prépolissage final des résines dentaires en Methylmetacrylate.  
 Surtido de pulido con dico de paño ZETA, gasa de algodón estrecha y pasta Polistar Lintygris para el prepolido así como un frasco de emulsión para el pulido final de plásticos dentales de metacrilatos metílicos.  
 Assortimento per lucidare contenente disco in panno "ZETA", moscione con fili di cotone sottili, pasta Polistar Lintygrigio per prelucidare e Polistar Emulsione in flacone per la lucidatura finale della resina dentale.

Inhalt, contents, contenu, contenido, contenuto:  
 1x 862 80/15 / 1x 152 80 BW / 1x Polistar Lintygrau 300 g / 1x Polistar Emulsion 125 ml

#### ThermoPol Set ID Nr. 313203

#### RapidPol Set ID Nr. 313210



3 Schritte-Poliererset für thermoplastische Kunststoffe. Schnelle Vorpolitur mit Einlegebürste und Polistar Lintygrau. Effektive Glanzpolitur mit COSIMA Soft Schwabbel + Creme. Perfekten Hochglanz mit Polistar Pro Pink.  
 3 Steps Thermoplastic Polishing Kit. Fast and easy pre-polishing with Scotch Brite™ Multi Layer brush and Polistar Lintygrey. Effective shine polishing with COSIMA Soft buff + Cream. Perfect high shine polishing with Polistar Pro Pink.  
 Kit de 3 étapes de polissage pour polir les thermoplastiques. Pré-polissage rapide avec brosse intercalé et Polistar Lintygris. Poli brillant avec la disque COSIMA Soft et crème à polir Polistar. Lustrage avec la pate à polir Polistar Pro Pink  
 Tres pasos para termoplástico. Prepolido rápido con cepillo con entretelas y Polistar Lintygris. Pulido efectivo con disco de COSIMA Soft + Crema. Abrillantado perfecto con Polistar Pro Pink  
 Set per lucidare le resine in termoplastica in tre passaggi. Veloce prelucidatura con il disco multistrato e la pasta per lucidare Polistar Lintygrigio. Effettiva lucidatura con i dischi COSIMA morbidi + crema. Una perfetta lucidatura a specchio con Polistar Pro Pink.

Inhalt, contents, contenu, contenido, contenuto:  
 1x Polistar Lintygrau 90g / 2x 4280 / 1x Polistar Creme 90g / 1x 869 100/14 / 1x Polistar Pro Rosa 150g / 1x 868 4"x50 H



**§ 1 Geltungsbereich – Vertragsgegenstand**

(1) Unsere AGB gelten für die Herstellung und Lieferung von beweglichen Sachen nach Maßgabe des zwischen uns und dem Kunden geschlossenen Vertrags. Sie richten sich ausschließlich an natürliche oder juristische Personen oder rechtsfähigen Personengesellschaften in Ausübung ihrer gewerblichen oder selbständigen beruflichen Tätigkeit (Unternehmer).

(2) Unsere AGB gelten ausschließlich. Entgegenstehende oder von unseren AGB abweichende Bedingungen des Kunden erkennen wir nicht an, es sei denn, wir haben ausdrücklich schriftlich ihrer Geltung zugestimmt.

(3) Unsere AGB gelten auch dann, wenn wir in Kenntnis entgegenstehender oder von unseren Geschäftsbedingungen abweichender Bedingungen des Kunden die Lieferung vorbehaltlos ausführen. Sie gelten auch für alle zukünftigen Lieferungen, Leistungen oder Angebote an den Kunden, auch wenn sie nicht nochmals gesondert vereinbart werden.

**§ 2 Angebot – Vertragsschluss**

(1) Die Bestellung des Kunden stellt ein bindendes Angebot dar, das wir innerhalb von zwei Wochen durch Zusendung einer Auftragsbestätigung oder durch Lieferung der Ware annehmen können. Vorher abgegebene Angebote durch uns sind freibleibend und unverbindlich.

(2) An Abbildungen, Zeichnungen, Kalkulationen und sonstigen Unterlagen behalten wir uns Eigentums- und Urheberrechte vor. Dies gilt auch für solche schriftlichen Unterlagen, die als vertraulich bezeichnet sind. Vor ihrer Weitergabe an Dritte bedarf der Kunde unserer ausdrücklichen schriftlichen Zustimmung.

**§ 3 Preise und Zahlungsbedingungen**

(1) Es gilt unsere zum Zeitpunkt des Vertragsschlusses gültige Preisliste für den in der Auftragsbestätigung aufgeführten Leistungs- und Lieferungsumfang. Die Preise verstehen sich in EURO ab Werk zuzüglich Verpackung, Versand, gesetzlicher Umsatzsteuer sowie gegebenenfalls Zoll, Gebühren und anderer öffentlicher Abgaben.

(2) Hat sich der Preis zum Zeitpunkt der Leistungserbringung durch eine Änderung des Marktpreises oder durch Erhöhung der von in die Leistungserbringung einbezogenen Dritten verlangten Entgelte erhöht, gilt der höhere Preis. Liegt dieser 20 % oder mehr über dem vereinbarten Preis, hat der Kunde das Recht, vom Vertrag zurückzutreten. Dieses Recht unverzüglich nach Mitteilung des erhöhten Preises geltend gemacht werden.

(3) Die Gesamtvergütung ist unmittelbar mit Rechnungsstellung fällig und ohne jeden Abzug zu zahlen, sofern nichts anderes vereinbart ist. Zahlungen sollen nur durch Banküberweisung erfolgen. Wechsel- und Scheckzahlungen erkennen wir nicht als Erfüllung an.

(4) Leistet der Kunde bei Fälligkeit nicht, so sind die ausstehenden Beträge nach §§ 352, 353 HGB ab dem Tag der Fälligkeit mit 5 % jährlich zu verzinsen. Zahlt der Kunde innerhalb von 21 Tagen ab Rechnungsstellung nicht, kommt er in Verzug, ohne dass es hierfür einer Mahnung bedarf. Der Kaufpreis ist während des Verzugs mit 8 Prozentpunkten über dem Basiszinssatz jährlich zu verzinsen. Die Geltendmachung weiterer Rechte aus Verzug des Kunden behalten wir uns vor.

(5) Aufrechnungsrechte und Zurückbehaltungsrechte stehen dem Kunden nur zu, wenn seine Gegenansprüche rechtskräftig festgestellt, unbestritten oder von uns anerkannt sind.

**§ 4 Lieferung - Gefahrübergang – Leistungszeit**

(1) Sofern sich aus der Auftragsbestätigung nichts anderes ergibt, ist Lieferung ab Werk vereinbart.

(2) Wir sind berechtigt, uns zur Erfüllung unserer vertraglichen Lieferverpflichtungen Dritter zu bedienen. Die Gefahr geht spätestens mit der Übergabe des Liefergegenstandes an den Spediteur, Frachtführer oder sonst zur Ausführung bestimmten Dritten auf den Kunden über. Dies gilt auch für Teillieferungen. Verzögert sich der Versand oder die Übergabe infolge eines Umstandes, dessen Ursache beim Kunden liegt, geht die Gefahr von dem Tag an auf den Kunden über, an dem der Liefergegenstand versandbereit ist und der Verkäufer dies dem Kunden angezeigt hat.

(3) Sind von uns Lieferfristen angegeben und zur Grundlage für die Auftragserteilung gemacht worden, verlängern sich solche Fristen bei Streik und höherer Gewalt für die Dauer der Verzögerung.

**§ 5 Haftung für Mängel**

(1) Bei Vorliegen eines Mangels behalten wir uns die Wahl der Art der Nacherfüllung (Nachbesserung oder Ersatzlieferung) vor.

(2) Die Gewährleistungsfrist beträgt ein Jahr ab Lieferung. Dies gilt nicht, soweit es sich um Schadensersatzansprüche wegen Mängeln handelt. Für Schadensersatzansprüche wegen eines Mangels gilt § 6. Die Verjährungsfrist im Fall eines Lieferregresses nach den §§ 478, 479 BGB bleibt unberührt.

**§ 6 Haftung für Schäden**

(1) Unsere Haftung für vertragliche Pflichtverletzungen sowie aus Delikt ist auf Vorsatz und grobe Fahrlässigkeit beschränkt. Dies gilt nicht bei Verletzung von Leben, Körper und Gesundheit des Kunden und bei Verletzung von Kardinalpflichten, d.h. von solchen Pflichten, die sich aus der Natur des Vertrags ergeben und bei deren Verletzung die Erreichung des Vertragszwecks gefährdet ist. Insoweit haften wir für jeden Grad des Verschuldens. Für Schäden, die nicht aus der Verletzung von Leben, Körper und Gesundheit des Kunden resultieren, haften wir jedoch nur für den vertragstypischen, vorhersehbaren Schaden.

(2) Die vorgenannte Haftungsbeschränkung gilt auch für leicht fahrlässige Pflichtverletzungen unserer Erfüllungsgehilfen.

(3) Soweit eine Haftung für Schäden, die nicht auf der Verletzung von Leben, Körper oder Gesundheit des Kunden beruhen, für leichte Fahrlässigkeit nicht ausgeschlossen ist, verjähren derartige Ansprüche innerhalb eines Jahres. Die Verjährung beginnt mit der Entstehung des Anspruchs, bei Schadensersatzansprüchen wegen eines Mangels ab Übergabe der Sache.

(4) Soweit die Schadensersatzhaftung uns gegenüber ausgeschlossen oder eingeschränkt ist, gilt dies auch im Hinblick auf die persönliche Schadensersatzhaftung unserer Angestellten, Arbeitnehmer, Mitarbeiter, Vertreter und Erfüllungsgehilfen.

(5) Die Vorschriften des Produkthaftungsgesetzes bleiben unberührt.

**§ 7 Eigentumsvorbehalt**

(1) Wir behalten uns das Eigentum an der Ware bis zur Erfüllung sämtlicher Forderungen gegen den Kunden vor, auch wenn die konkrete Ware bereits bezahlt wurde.

(2) Über Zwangsvollstreckungsmaßnahmen Dritter in die Vorbehaltsware hat uns der Kunde unverzüglich unter Übergabe der für eine Intervention notwendigen Unterlagen zu unterrichten. Unabhängig davon hat der Kunde die die Zwangsvollstreckung betreibenden Gläubiger auf die an der Ware bestehenden Rechte hinzuweisen. Der Kunde hat die Kosten unserer Intervention zu tragen, wenn der die Zwangsvollstreckung betreibende Dritte nicht in der Lage ist, diese zu erstatten.

(3) Für den Fall der Weiterveräußerung der Vorbehaltsware tritt uns der Kunde schon jetzt bis zur Erfüllung aller unserer Ansprüche die ihm aus der Weiterveräußerung entstehenden Forderungen gegen seine Kunden zur Sicherheit ab. Bei einer Verarbeitung der Vorbehaltsware, ihrer Umbildung oder ihrer Verbindung mit einer anderen Sache erwerben wir unmittelbar Eigentum an der hergestellten Sache. Diese gilt als Vorbehaltsware.

(4) Übersteigt der Wert der Sicherung unsere Ansprüche gegen den Kunden um mehr als 20 %, so haben wir auf Verlangen des Kunden und nach unserer Wahl uns zustehende Sicherheiten in entsprechendem Umfang freizugeben.

**§ 8 Verjährung eigener Ansprüche**

Unsere Ansprüche auf Zahlung verjähren abweichend von § 195 BGB in fünf Jahren. Hinsichtlich des Verjährungsbeginns gilt § 199 BGB.

**§ 9 Form von Erklärungen**

Rechtserhebliche Erklärungen und Anzeigen und die der Kunde gegenüber uns oder einem Dritten abzugeben hat, bedürfen der Schriftform.

**§ 10 Erfüllungsort – Rechtswahl – Gerichtsstand**

(1) Soweit sich aus dem Vertrag nichts anderes ergibt, ist Erfüllungsort und Zahlungsort unser Geschäftssitz.

(2) Für diesen Vertrag gilt das Recht der Bundesrepublik Deutschland unter Ausschluss des UN-Kaufrechts.

(3) Ausschließlicher Gerichtsstand ist bei Verträgen mit Kaufleuten, juristischen Personen des öffentlichen Rechts oder öffentlich-rechtlichen Sondervermögen das für unseren Geschäftssitz zuständige Gericht.







**HATHO** GmbH

Gewerbepark Breisgau  
Freiburger Straße 18  
79427 Eschbach  
Germany

Tel. +49 76 34 50 39-0  
Fax. +49 76 34 50 39-22

info@hatho.de  
www.hatho.de

